

ARROW

ARROW

IN THE HAND OF A WARRIOR

FOCUS

PSALM 127:4, PROVERBS 4:1-3, 11 & 25-26

Your Tiny Arrow is an arrow! They are meant to learn from their bow, father, so that when they are released they can remember their instructions and obey right away!

MATERIALS

Bow and Arrow picture (1 per child)
Bow and Arrow (1 set per child)
Target
Crayons, paint, marker and tape

ACTIVITIES

1. INTRODUCTION

TALK: When a father has a child they are like a warrior and their child an arrow!

ACTIVITY: Color the picture of the father holding a bow and the son an arrow.

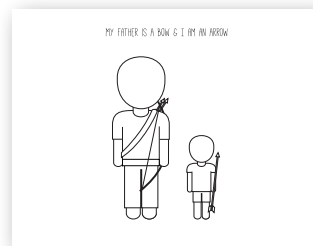

CORRESPONDING VERSE

LIKE ARROWS IN THE HANDS OF A WARRIOR ARE CHILDREN BORN IN ONES YOUTH.

PSALM 127:4

2. BOW & ARROW

TALK: A bow and arrow is like a someone who is discipling someone (a father), and someone who is being disciplined (a child). The father will train, teach and release their child for their calling.

ACTIVITY: Have child paint an arrow. While he is painting say Proverbs 4:1-2. After the arrow is dry, write the child's name on the arrow, and their father's name on the bow.



LISTEN, MY SONS, TO A FATHER'S INSTRUCTIONS; PAY ATTENTION AND GAIN UNDERSTANDING. I GIVE YOU SOUND LEARNING, SO DO NOT FORSAKE MY TEACHING.

PROVERBS 4:1-2

ACTIVITIES

3. TAKE HOLD

TALK: As an arrow you are suppose to take hold of your father's words. You should listen to what he says and obey the first time!

ACTIVITY: Write a scripture or God's purpose for your family on the target then have your Tiny Arrow grab a hold of the arrow as you tell them what it says on the target! Hang the target on the wall (somewhere you can shoot the arrow at).

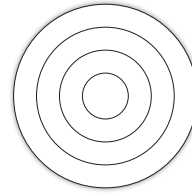

CORRESPONDING VERSE

THEN HE TAUGHT ME,
AND HE SAID TO ME,
"TAKE HOLD OF MY WORDS
WITH ALL YOUR HEART;
KEEP MY COMMANDS,
AND YOU WILL LIVE."

PROVERBS 4:3

4. SEE & OBEY

TALK: When you're an arrow, you need to fix your eyes on where your father is telling you to go. He will help you go straight and right where you need to go!

ACTIVITY: Play I spy, encouraging your Tiny Arrow to look for what your are explaining and to fix their gaze on it. Use the target as one of the items you have them try to find.

LET YOUR EYES LOOK STRAIGHT
AHEAD; FIX YOUR GAZE
DIRECTLY BEFORE YOU. GIVE
CAREFUL THOUGHT TO THE
PATHS FOR YOUR FOR YOUR
FEET AND BE STEADFAST IN
ALL YOUR WAYS.

PROVERBS 4:25-26

5. FLY STRAIGHT

TALK: At the point when an arrow is being released, this is when your ear is by the mouth of the person holding the bow. What they are speaking, you are empowered to do! You can listen and obey! Your father will lead on you straight paths, and will help to show and tell you where you need to go.

ACTIVITY:  the bow and show them how when the bow is stretched the nock is right by your lips, then shoot the arrow at the target.

I INSTRUCT YOU IN THE
WAY OF WISDOM AND LEAD
YOU ALONG STRAIGHT PATHS.

PROVERBS 4:11

6. RELEASED

TALK: Once your parent has told you where you need to go and what you need to do, this is when you should quickly obey!

ACTIVITY: Have child walk or run to retrieve the arrow. Encourage them to go straight for the arrow.

DO NOT SET FOOT ON THE
PATH OF THE WICKED OR
WALK IN THE WAY OF
EVILDOERS. AVOID IT, DO NOT
TRAVEL ON IT; TURN FROM
IT AND GO ON YOUR WAY.

PROVERBS 4:14

OPTIONAL: Hand out each child a bible verse to take home.

LIKE ARROWS IN THE HANDS
OF A WARRIOR ARE CHILDREN
BORN IN ONES YOUTH.

PSALM 127:4

MY FATHER IS A BOW & I AM AN ARROW

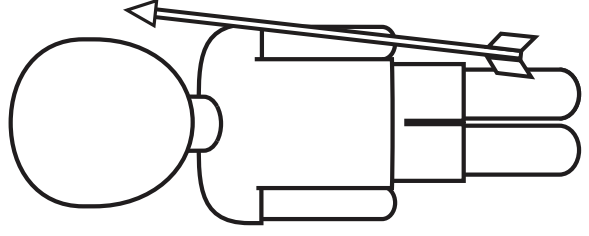
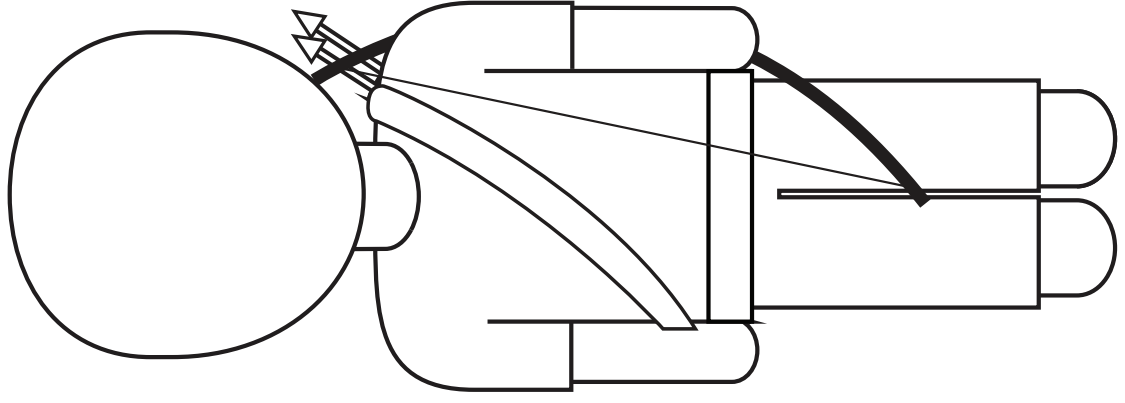

BOW & ARROW

30" LONG →
(1/4" X 3/4"
PVC COMPOSITE
SCREEN MOLDING)

ERASER CAPS



← 1/4" DOWEL 18" LONG



← TWINE

APPROX 1/8"

APPROX 1"

USING A SAW, CUT 1"
DOWN FROM THE EDGE
ON BOTH SIDES APPROX 1/8"





USING A SAW, CUT APPROX 1/4" IN THE MIDDLE
OF ONE SIDE OF THE ARROW TO FORM A NOCK

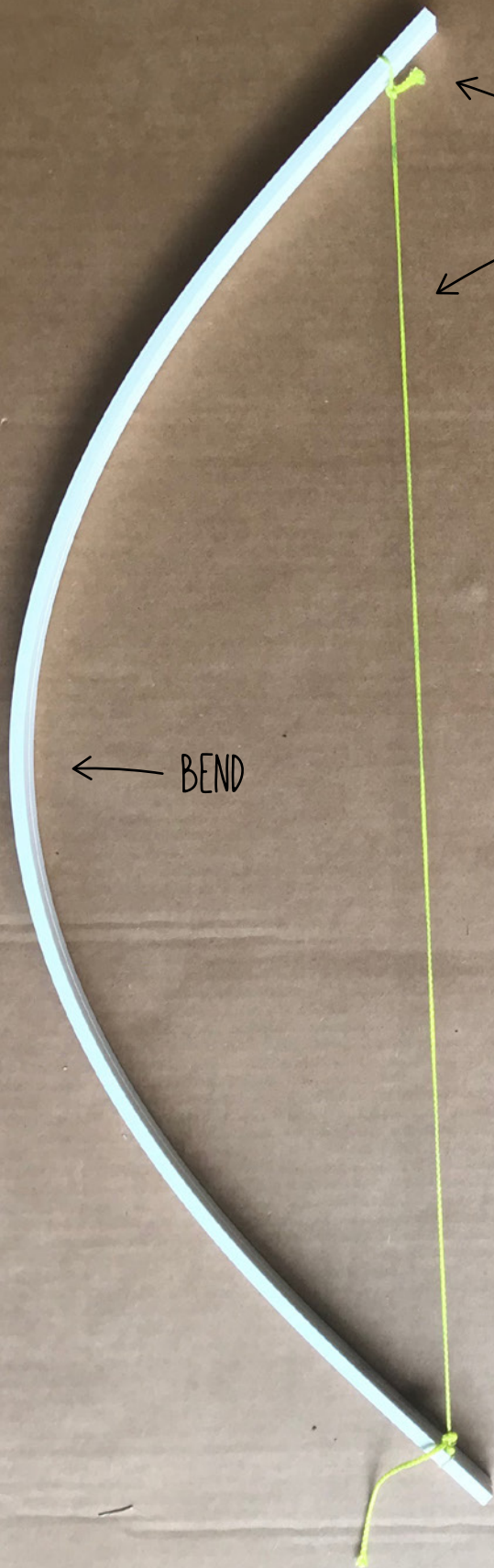

INSERT TWINE IN BOTH SIDES OF CUT HOLES AND TIE TOGETHER

BRING OTHER END OF STRING DOWN



INSERT A SMALL AMOUNT OF GLUE FROM A HOT GLUE GUN INTO THE ERASER CAP THEN INSERT THE DOWEL INTO THE ERASER CAP AND PRESS FIRMLY UNTIL DRY

BEND

INSERT TWINE IN BOTH SIDES OF CUT HOLES AND TIE TOGETHER

CUT OUT TARGET & HANG IN A SAFE LOCATION THAT IT CAN BE SHOT AT

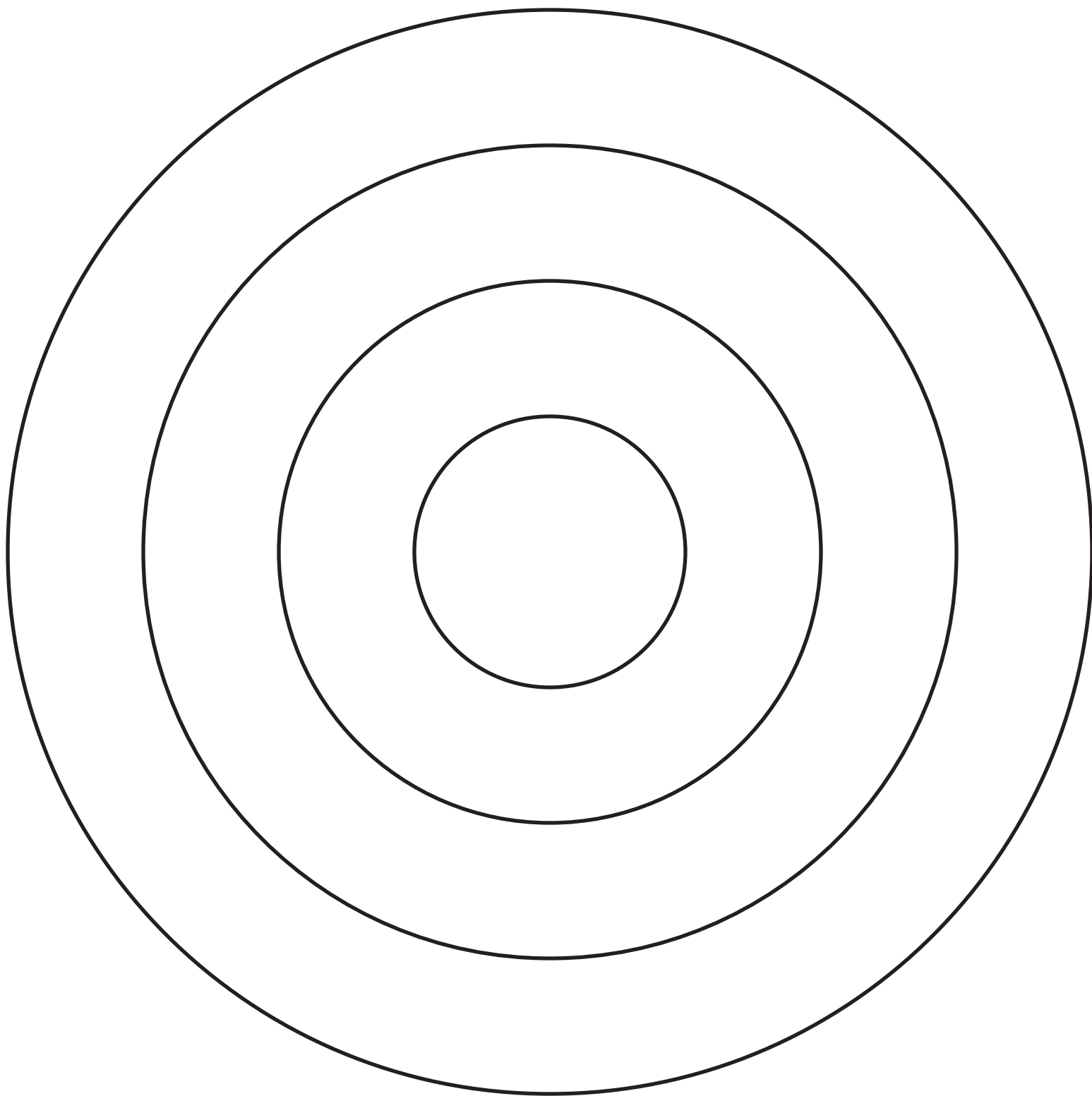

LIKE ARROWS IN THE HANDS
OF A WARRIOR ARE CHILDREN
BORN IN ONES YOUTH.

PSALM 127:4

LIKE ARROWS IN THE HANDS
OF A WARRIOR ARE CHILDREN
BORN IN ONES YOUTH.

PSALM 127:4

LIKE ARROWS IN THE HANDS
OF A WARRIOR ARE CHILDREN
BORN IN ONES YOUTH.

PSALM 127:4

LIKE ARROWS IN THE HANDS
OF A WARRIOR ARE CHILDREN
BORN IN ONES YOUTH.

PSALM 127:4