

# SWORD OF THE SPIRIT

## SWORD OF THE SPIRIT

## WORD OF GOD

---

### FOCUS

JOSHUA 8:18, 1 SAMUEL 14:6-7 PSALM 127:4, LUKE 6:40,  
JOHN 10:11, EPHESIANS 6:17 & HEBREWS 4:12

The Sword of the Spirit is the Word  
of God!

### MATERIALS

Holding sword coloring page (1 per child)  
Sword (1 per child)  
Sword of the Spirit cards (6 per child)  
Jesus' Return coloring page (1 per child)  
Jesus display (1 per child)  
Crayons, scissors and glue

### ACTIVITIES

#### 1. INTRODUCTION

**TALK:** The Sword of the Spirit is part of the  
Armor of God.

**ACTIVITY:** Draw yourself holding a sword.



### CORRESPONDING VERSE

#### 2. ALIVE & ACTIVE

**TALK:** The Sword of the Spirit is alive and active.

**ACTIVITY:** Write "Word of God" on one side of the sword  
and "Alive and Active" on the other.



FOR THE WORD OF GOD IS  
ALIVE AND ACTIVE. SHARPER  
THAN ANY DOUBLE-EDGED  
SWORD, IT PENETRATES EVEN  
TO DIVIDING SOUL AND SPIRIT,  
JOINTS AND MARROW; IT  
JUDGES THE THOUGHTS AND  
ATTITUDES OF THE HEART.

HEBREWS 4:12

## ACTIVITIES

### 3. WORD OF GOD

**TALK:** The Sword of the Spirit is the Word of God. It can be used at specific times for specific needs.

**ACTIVITY:** Write down a few verses from the Bible on the Sword of the Spirit cards.



## CORRESPONDING VERSE

THE SWORD OF THE SPIRIT,  
WHICH IS THE WORD OF GOD.  
EPHESIANS 6:17

### 4. JESUS' RETURN

**TALK:** Jesus is coming back on a white horse and he will have a sword coming from his mouth!

**ACTIVITY:** Color the page of Jesus on his horse in the clouds.

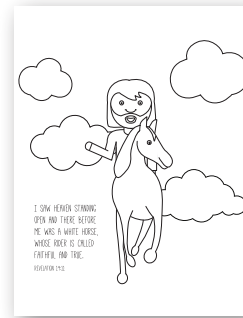

I SAW HEAVEN STANDING  
OPEN AND THERE BEFORE  
ME WAS A WHITE HORSE,  
WHOSE RIDER IS CALLED  
FAITHFUL AND TRUE.  
REVELATION 19:11

### 5. SWORD FROM HIS MOUTH

**TALK:** When Jesus comes down from heaven, he will have a sword in his mouth that will strike down nations. The sword is God's Word!

**ACTIVITY:** Color the Jesus display and place the Sword of the Spirit cards on the back, in their holder. When needed, you can push the Sword of the Spirit card through Jesus' mouth and into your hand!



COMING OUT OF HIS MOUTH  
IS A SHARP SWORD WITH  
WHICH TO STRIKE DOWN  
THE NATIONS.  
REVELATION 19:15

**OPTIONAL:** Hand out each child a bible verse to take home.



THE SWORD OF THE SPIRIT

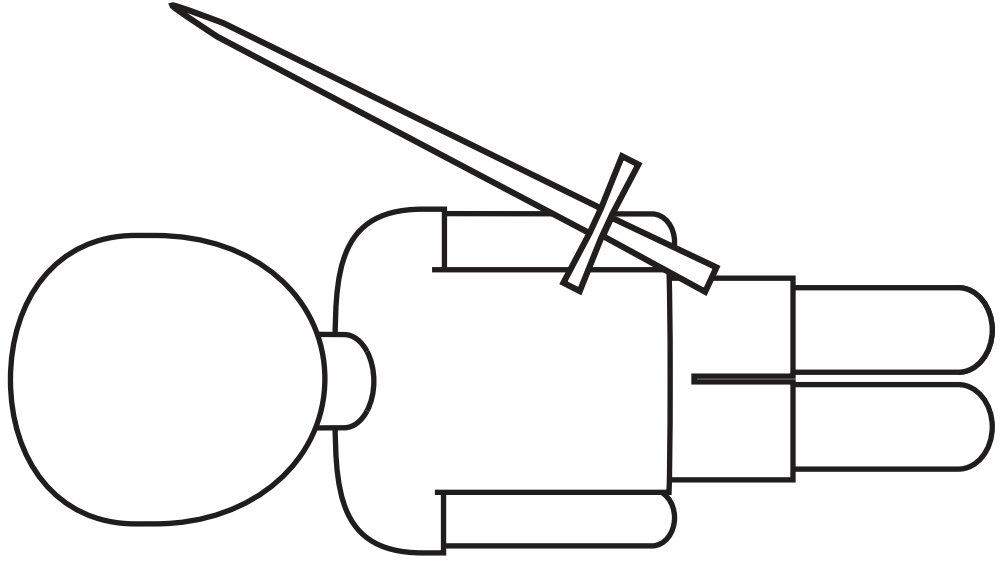



# SWORD

BLACK ELECTRICAL TAPE

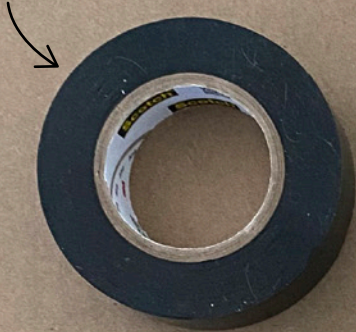

1 GALLON PAINT STICK



\*YOU WILL ALSO NEED  
WHITE & GRAY PAINT<sup>1</sup>  
& A GLUE GUN

<sup>1</sup>SPRAY PAINT OR CRAFT PAINT

2 JUMBO POPSICLE STICKS



## DIRECTIONS

1. LIGHTLY SAND PAINT STICK WITH  
120 SAND PAPER SO EDGES ARE  
SMOOTH AND ROUNDED



2. PRIME PAINT STICK WITH  
2 COATS OF WHITE PAINT  
(SAND WITH 220 SAND PAPER BETWEEN COATS)



3. PAINT STICK WITH 2 COATS  
OF GRAY PAINT  
(SAND WITH 220 SAND PAPER BETWEEN COATS  
& WHEN FINISHED USE 400 SAND PAPER TO SMOOTH)

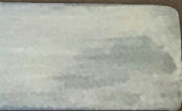

\*OPTIONAL: ADD THIRD PAINT COAT  
WITH SILVER PAINT

4. GLUE POPSICLE STICKS 5" FROM  
THE EDGE OF THE SWORD  
THEN WRAP WITH TAPE

1 STICK ON BOTTOM



1 STICK ON TOP

WRAP HERE FIRST  
TO COVER EDGE  
(BOTH SIDES)



THEN WRAP THE  
SIDES AND HILT  
IN A SPIRAL TO  
COVER ALL WOOD  
AND BIND THE  
STICKS TOGETHER

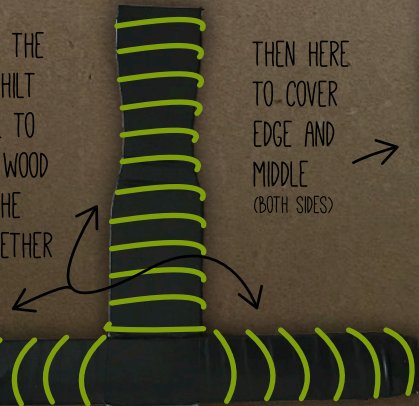

THEN HERE  
TO COVER  
EDGE AND  
MIDDLE  
(BOTH SIDES)





SWORD OF  
THE SPIRIT  
WHICH IS THE  
WORD OF GOD

SWORD OF  
THE SPIRIT  
WHICH IS THE  
WORD OF GOD

SWORD OF  
THE SPIRIT  
WHICH IS THE  
WORD OF GOD

SWORD OF  
THE SPIRIT  
WHICH IS THE  
WORD OF GOD

SWORD OF  
THE SPIRIT  
WHICH IS THE  
WORD OF GOD

SWORD OF  
THE SPIRIT  
WHICH IS THE  
WORD OF GOD



I SAW HEAVEN STANDING  
OPEN AND THERE BEFORE  
ME WAS A WHITE HORSE,  
WHOSE RIDER IS CALLED  
FAITHFUL AND TRUE.

REVELATION 19:11



# JESUS DISPLAY

PRINT

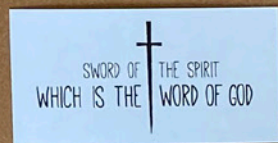
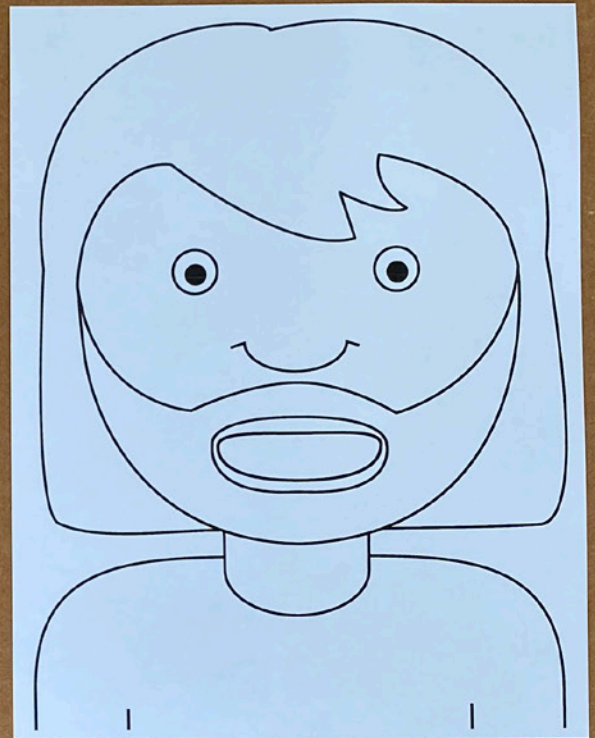

PRINT &  
CUT OUT

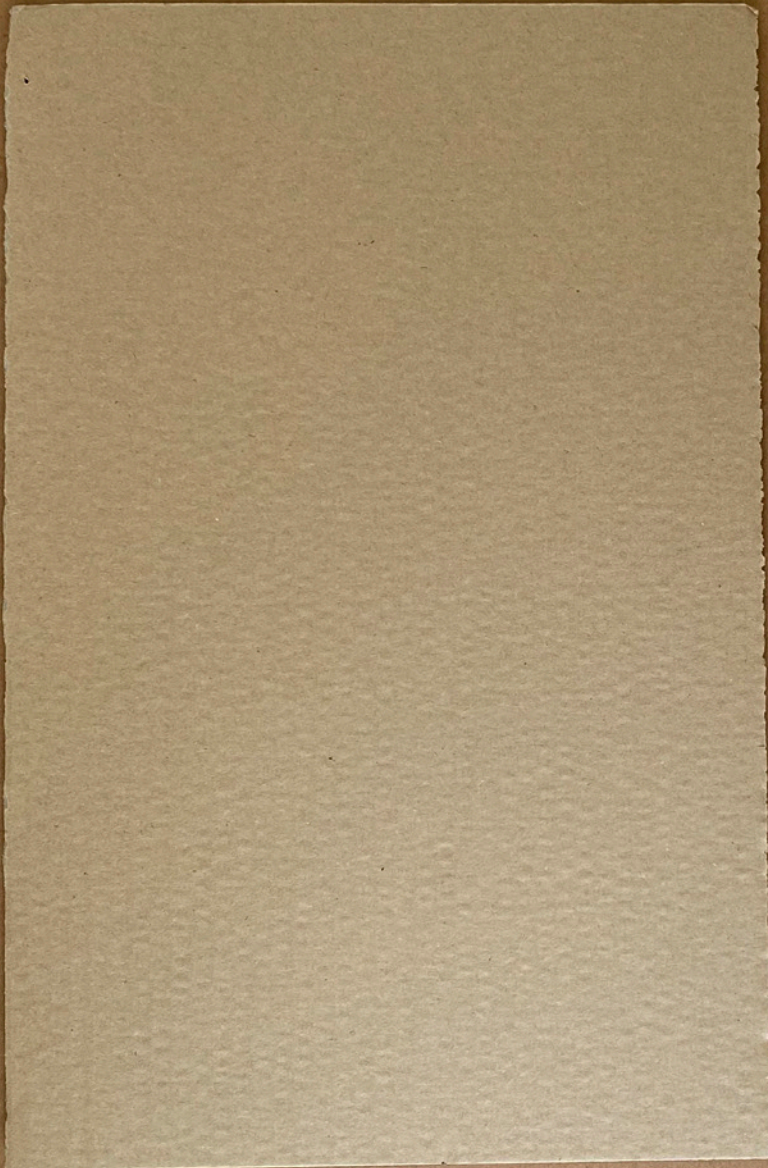
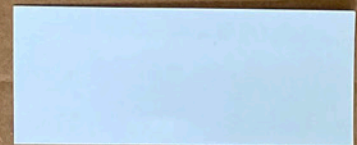

↑  
17X11 CARDBOARD  
(OR A STANDING DISPLAY)

↑  
2X5 CARDSTOCK



# JESUS DISPLAY

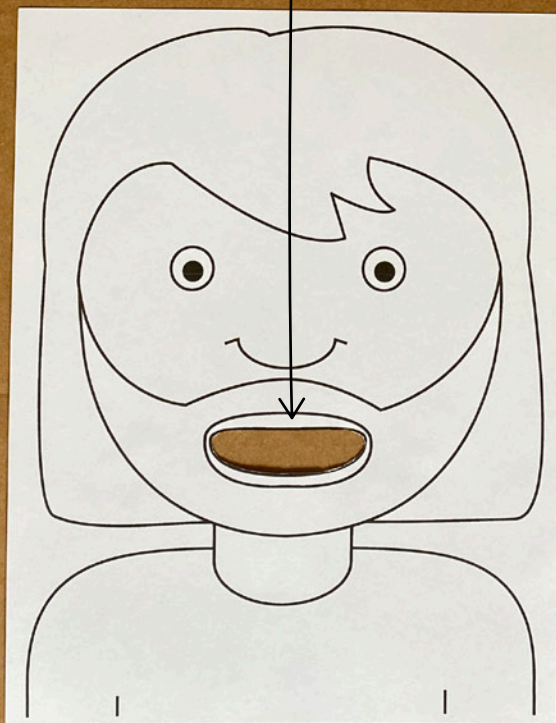
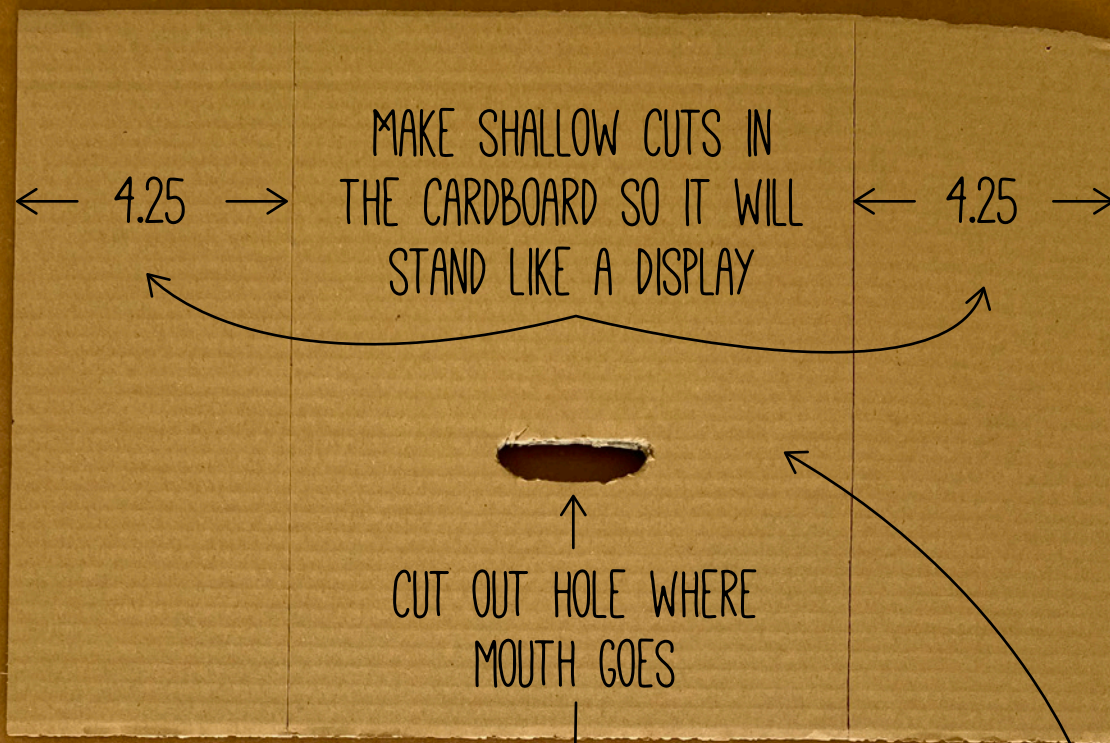

GLUE JESUS PAPER ON TO DISPLAY



# JESUS DISPLAY

GLUE OR TAPE THE EDGES OF THE CARDSTOCK PAPER  
ON BACK OF THE DISPLAY FOR THE  
SWORD OF THE SPIRIT CARDS TO SIT IN





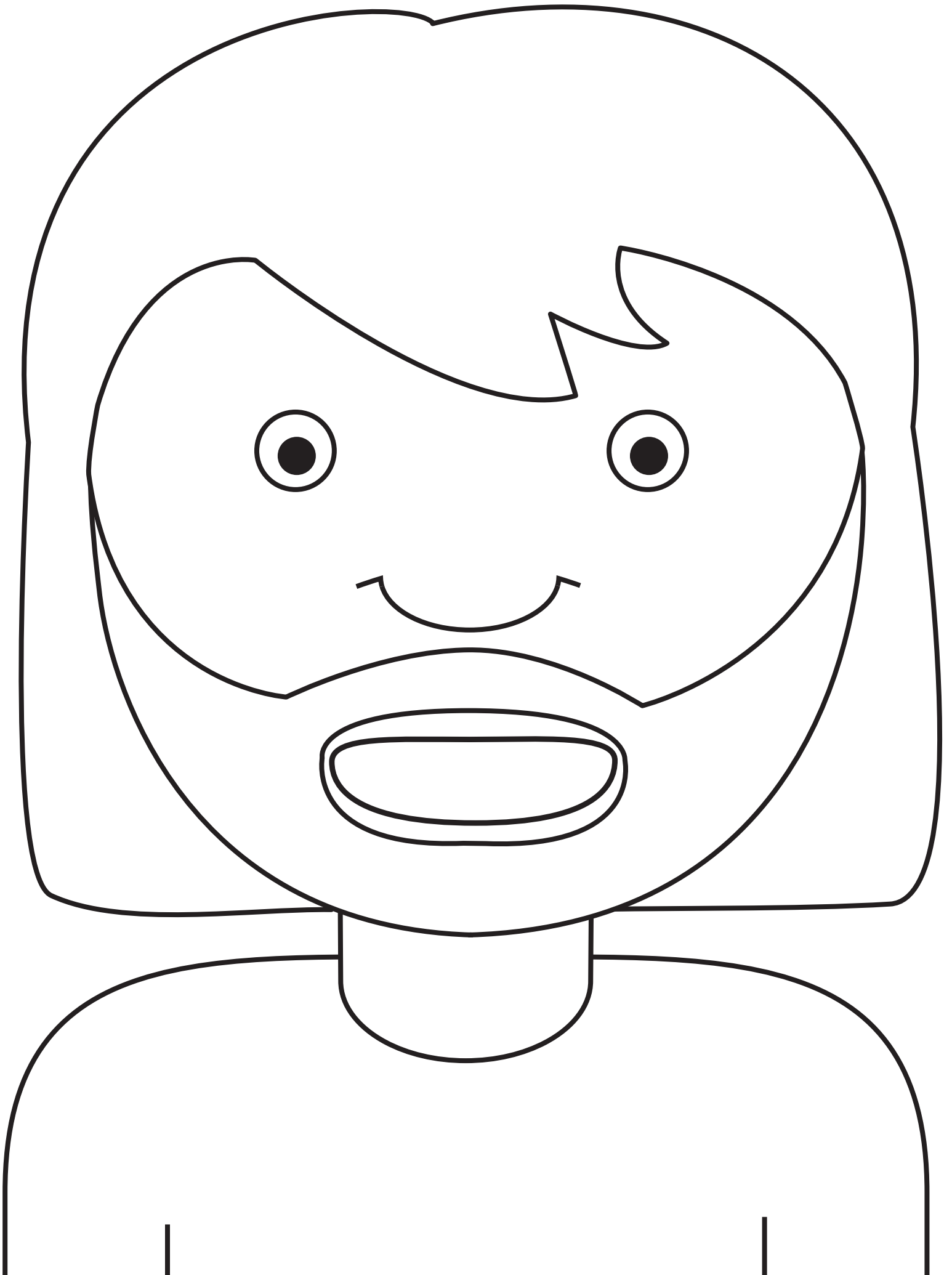



THE SWORD OF THE SPIRIT,  
WHICH IS THE WORD OF GOD.

EPHESIANS 6:17

THE SWORD OF THE SPIRIT,  
WHICH IS THE WORD OF GOD.

EPHESIANS 6:17

THE SWORD OF THE SPIRIT,  
WHICH IS THE WORD OF GOD.

EPHESIANS 6:17

THE SWORD OF THE SPIRIT,  
WHICH IS THE WORD OF GOD.

EPHESIANS 6:17