

THE TABERNACLE

THE TABERNACLE

PACKIN' UP

FOCUS

NUMBERS 3:6, 3:25 3:36, 4:15, 7:7-9 & 9:18

After Moses and the Israelites made the Tabernacle, they had to pack it up and move it around in the wilderness with the help of the Levites.

MATERIALS

Map of the Israelites coloring page (1 per child)
Aaron's Helpers coloring page (1 per child)
Holy Things, coverings and poles (1 set per child)
Curtains and poles (1 set per child)
Carts (2 per child)
Crayons, glue, scissors and tape

ACTIVITIES

1. INTRODUCTION

TALK: After Moses and the Israelites made the items for the tabernacle, they had to pack them up and carry them around the desert.

ACTIVITY: Color the map of the Israelites route in the desert and set up the Tabernacle.

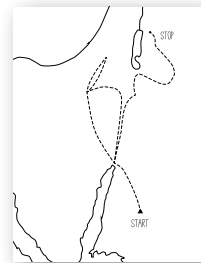

CORRESPONDING VERSE

AT THE LORD'S COMMAND
THE ISRAELITES SET OUT,
AND AT HIS COMMAND
THEY ENCAMPED.

NUMBERS 9:18

2. HELPERS

TALK: The Levites were there to help Aaron and his sons pack up the camp!

ACTIVITY: Color the Aaron's Helpers coloring page.

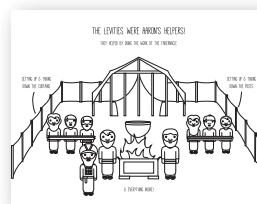

BRING THE TRIBE OF LEVI
AND PRESENT THEM TO
AARON THE PRIEST TO
ASSIST HIM.

NUMBERS 3:6

ACTIVITIES

3. HOLY THINGS

TALK: Aaron and his sons packed up the holy things: the Ark, Table, Incense Alter, Alter, Laver and Menorah; but the Kohathites carried them!

ACTIVITY: With the Tabernacle diagram already set up, point out the Ark, Incense Alter, Menorah, Table, Laver and Alter. Then pack up the holy articles. See pages 15–50 for instructions.



CORRESPONDING VERSE

AFTER AARON AND HIS SONS HAVE FINISHED COVERING THE HOLY FURNISHINGS...AND WHEN THE CAMP IS READY TO MOVE, ONLY THEN ARE THE KOHATHITES TO COME AND DO THE CARRYING.

NUMBERS 4:15

4. CURTAINS

TALK: The Gershonites were responsible for the curtains in the Tabernacle.

ACTIVITY: Color the **cart coloring page**, cut and glue it together. Then take the curtains down and place them in the cart.

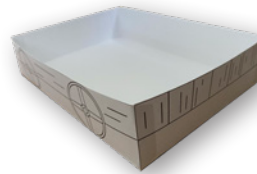

AT THE TENT OF MEETING THE GERSHONITES WERE RESPONSIBLE FOR THE CARE OF THE TABERNACLE AND TENT

NUMBERS 3:25

5. POLES

TALK: The Merarites were responsible for everything that held the curtains up.

ACTIVITY: Color the second **cart coloring page**, cut and glue it together. Then take the poles and put them in second cart.

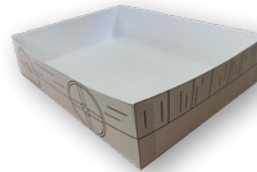

THE MERARITES WERE APPOINTED TO TAKE CARE OF THE FRAMES OF THE TABERNACLE, ITS CROSSBARS, POSTS, BASES, ALL ITS EQUIPMENT, AND EVERYTHING RELATED TO THEIR USE.

NUMBERS 3:36

6. CARRYING EVERYTHING

TALK: The Gershonites and Merarites were given carts and oxen to carry everything, but the Kohathites had to carry everything on their shoulders.

ACTIVITY: Move everything for the Tabernacle to a new location.

OPTIONAL: Set the Tabernacle back up.

OPTIONAL: Hand out each child a bible verse to take home.

AT THE LORD'S COMMAND THE ISRAELITES SET OUT, AND AT HIS COMMAND THEY ENCAMPED.

NUMBERS 9:18

HE GAVE TWO CARTS AND FOUR OXEN TO THE GERSHONITES, AS THEIR WORK REQUIRED, AND HE GAVE FOUR CARTS AND EIGHT OXEN TO THE MERARITES, AS THEIR WORK REQUIRED... BUT MOSES DID NOT GIVE ANY TO THE KOHATHITES, BECAUSE THEY WERE TO CARRY ON THE SHOULDERS THE HOLY THINGS.

NUMBERS 7:7-9

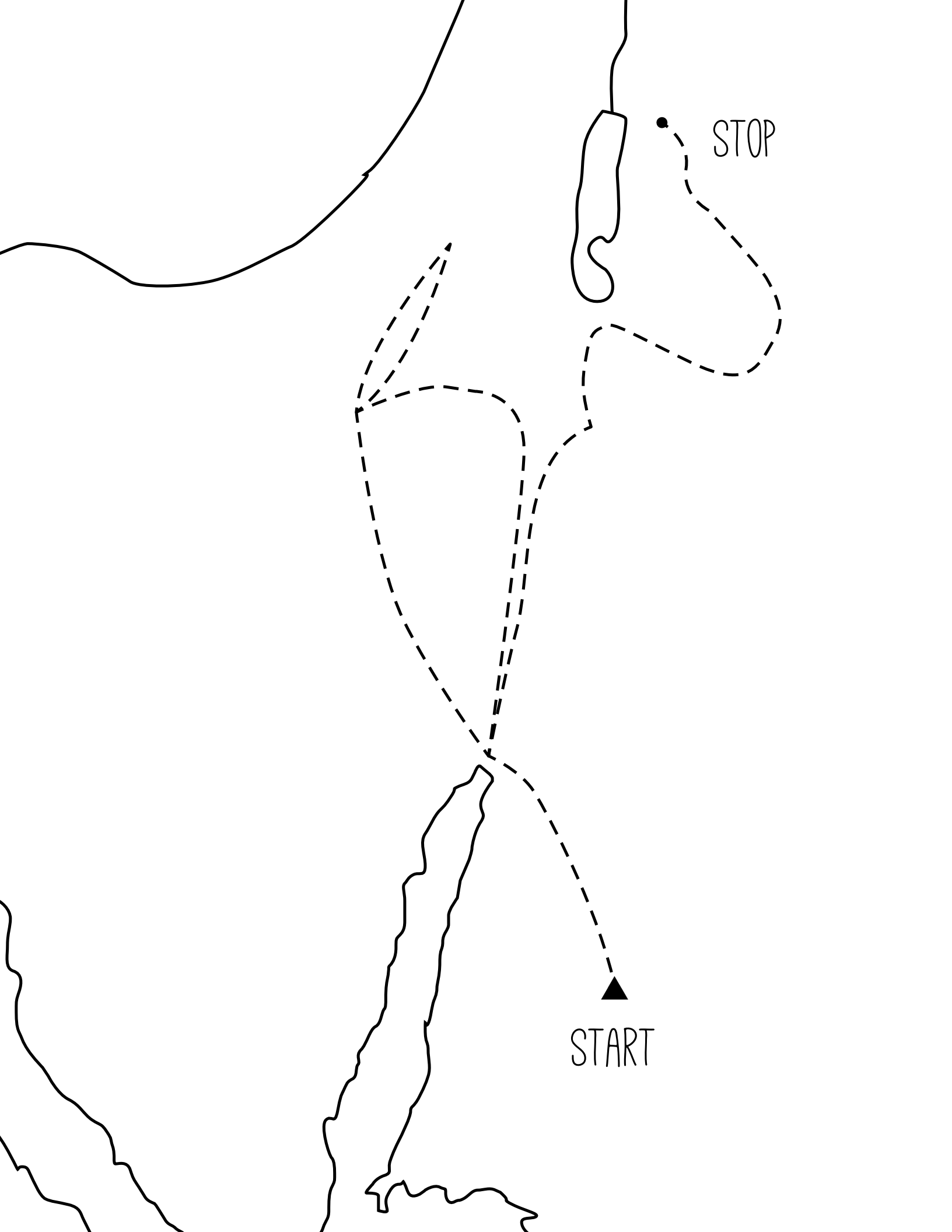

STOP

START

THE LEVITIES WERE AARON'S HELPERS!

THEY HELPED BY DOING THE WORK OF THE TABERNACLE

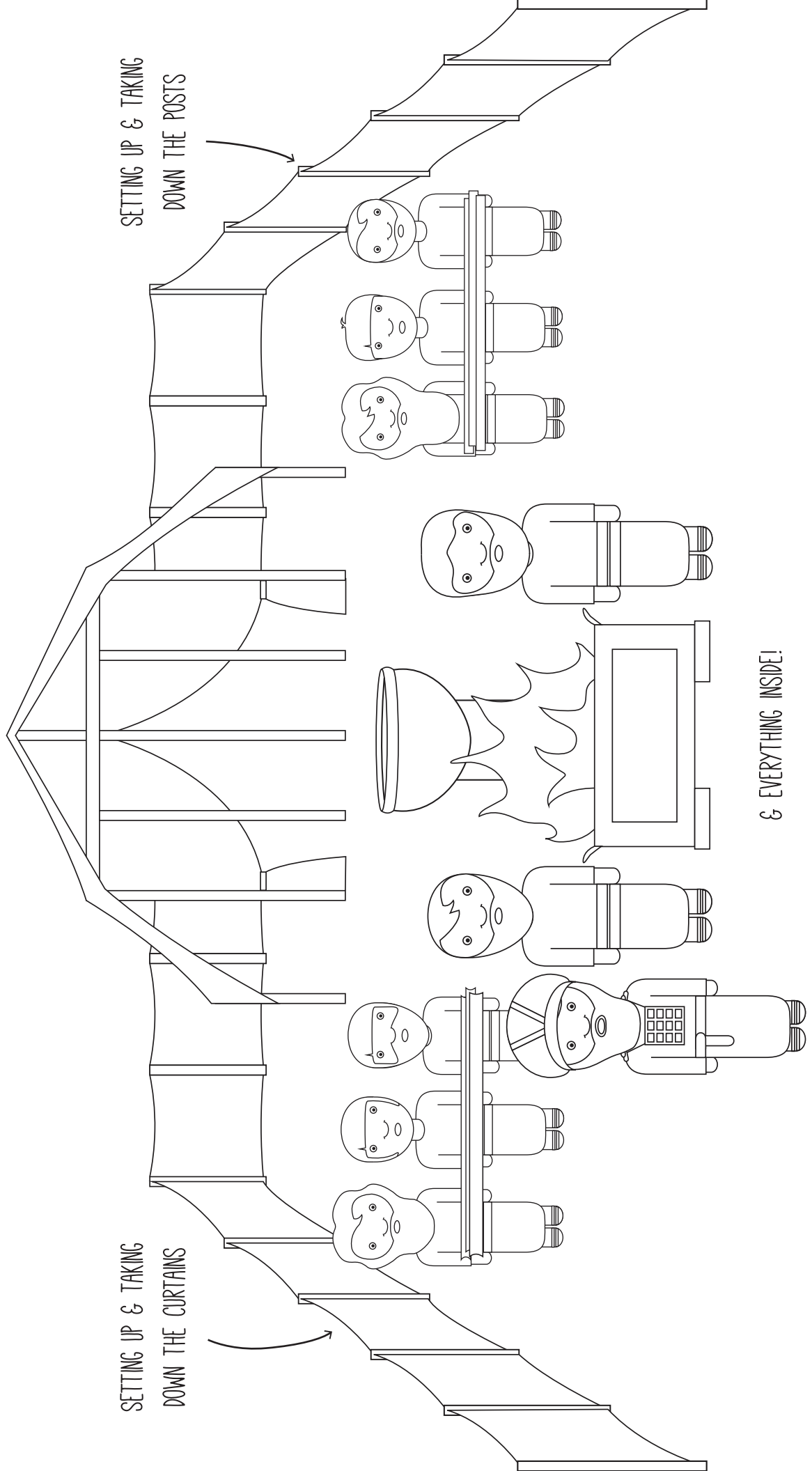

TABERNACLE

14.75IN X 10IN BOX LID
SPRAY PAINTED BLACK

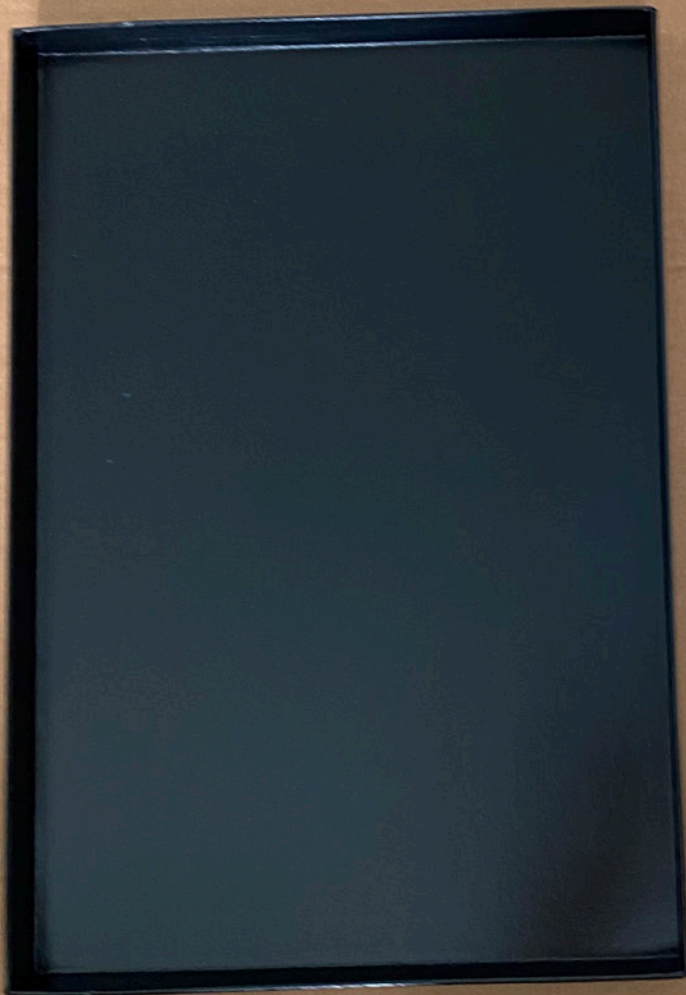

4 PIECES OF 9IN X 12IN
BLUE FELT

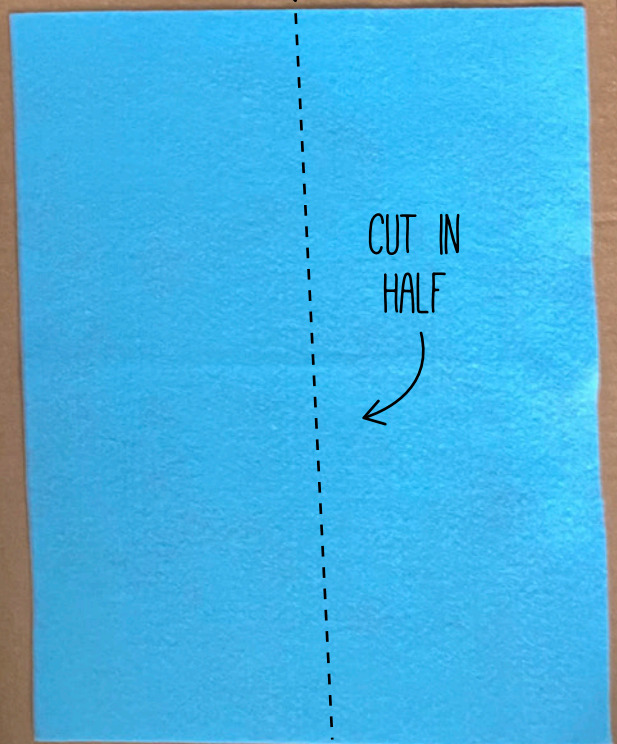

12 .125IN X
12IN DOWEL

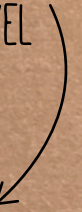

CUT IN
HALF



← 23 BRONZE PONY BEADS

TABERNACLE

PLACE & GLUE THE PONY BEADS ON THE
INSIDE OF THE BOX LID



GLUE THE
OUTSIDE EDGE
BEADS .5" UP
FROM THE
BOTTOM OF
THE LID



TABERNACLE

CUT THE FELT

5.5" X 4.5" (6 PIECES)

5" X 4.5" (2 PIECES)

4.5" X 4.5" (2 PIECES)

4" X 4.5" (4 PIECES)

3.5" X 4.5" (4 PIECES)

2.5" X 4.5" (2 PIECES)

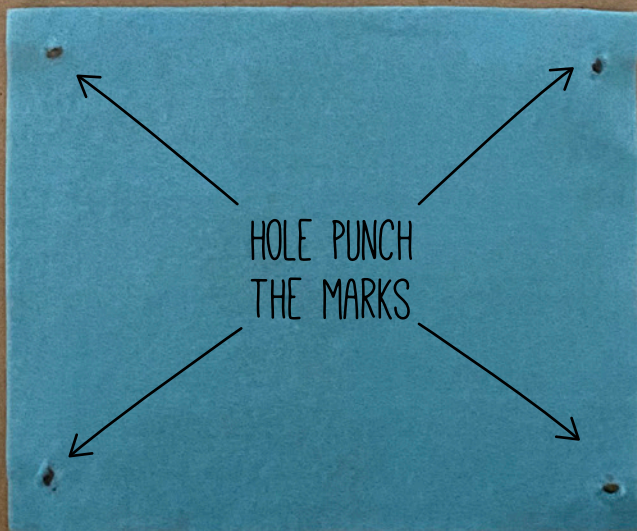
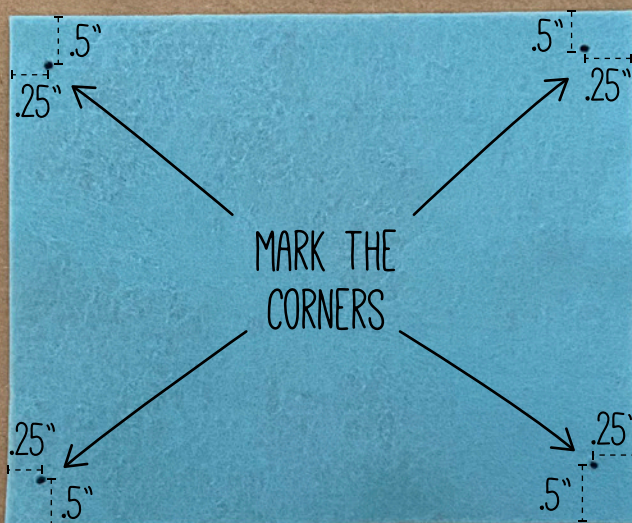

TABERNACLE

FELT PIECES MAP
THE FELT IS MEANT TO OVERLAP

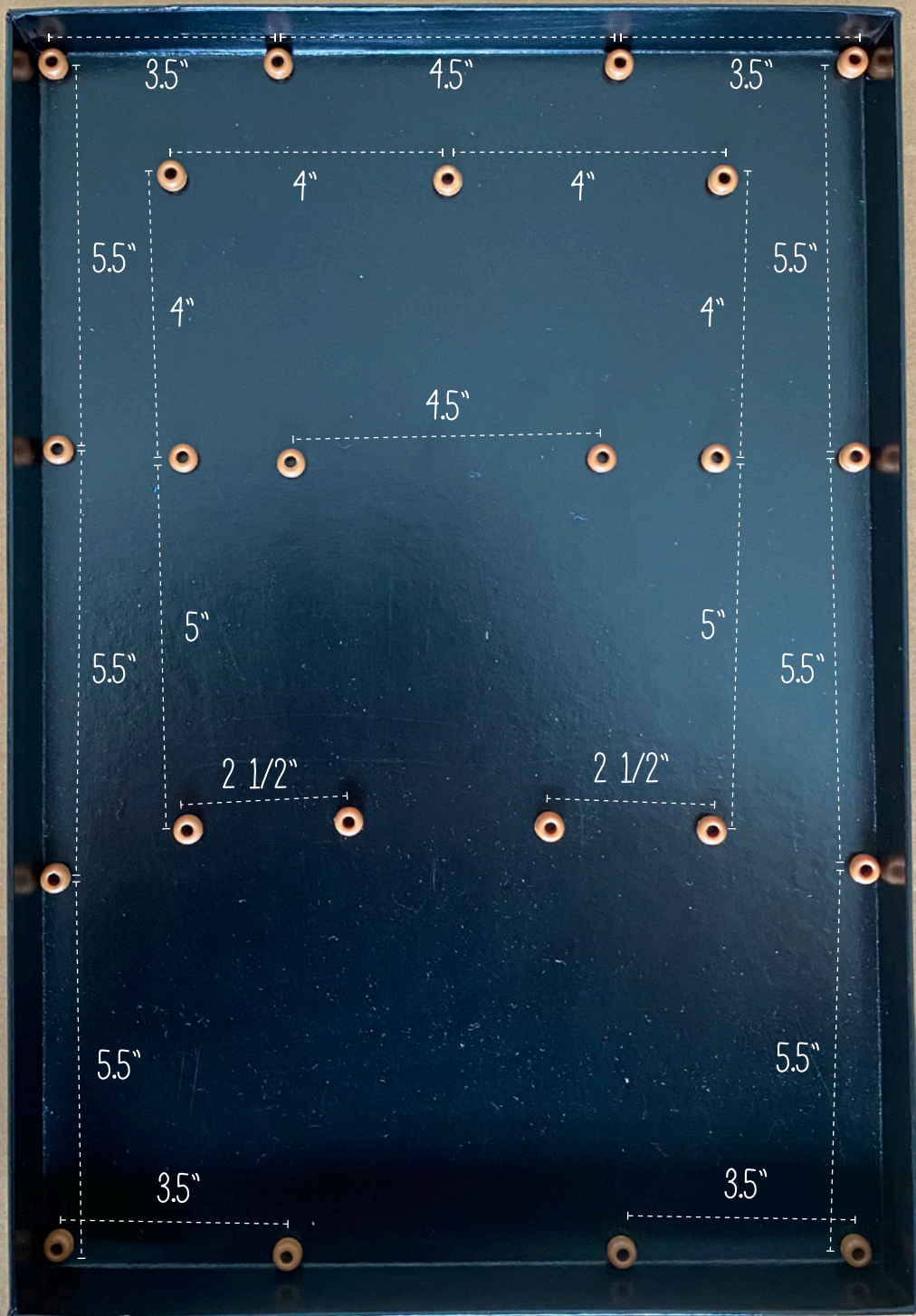

TABERNACLE

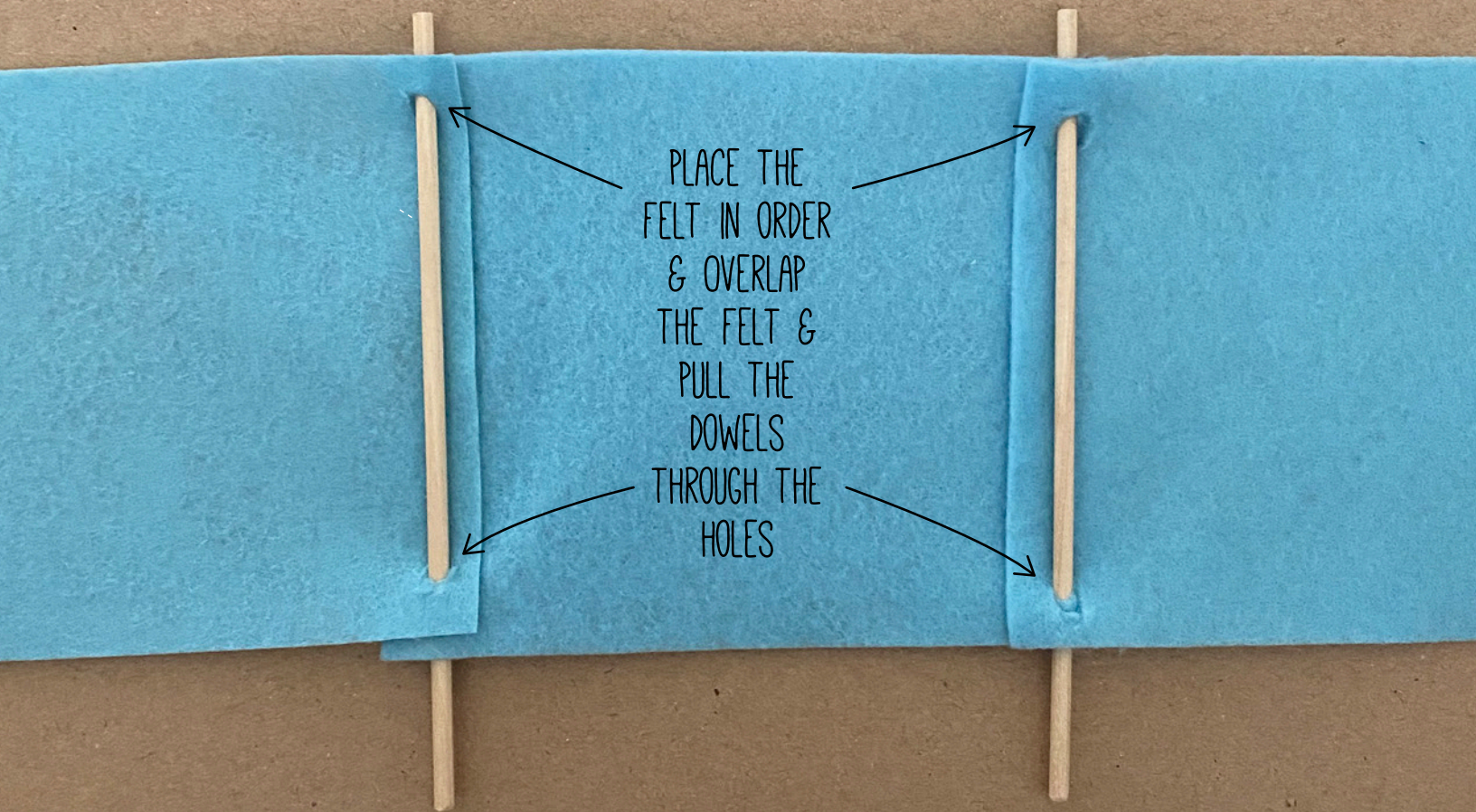

TABERNACLE



PLACE THE FELT
& DOWELS IN
THE BEADS GLUED
ON THE BOX



TABERNACLE



ARK

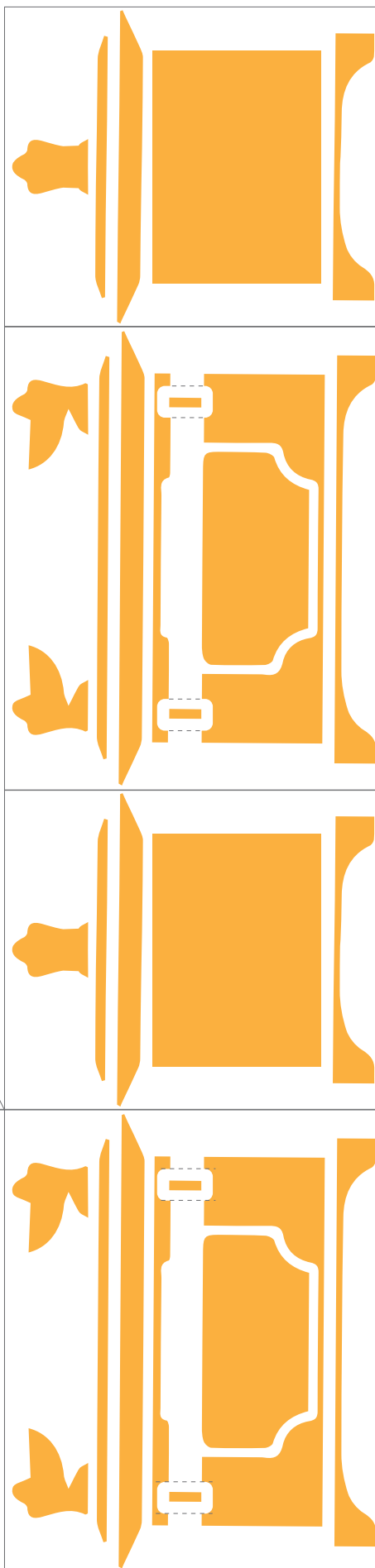
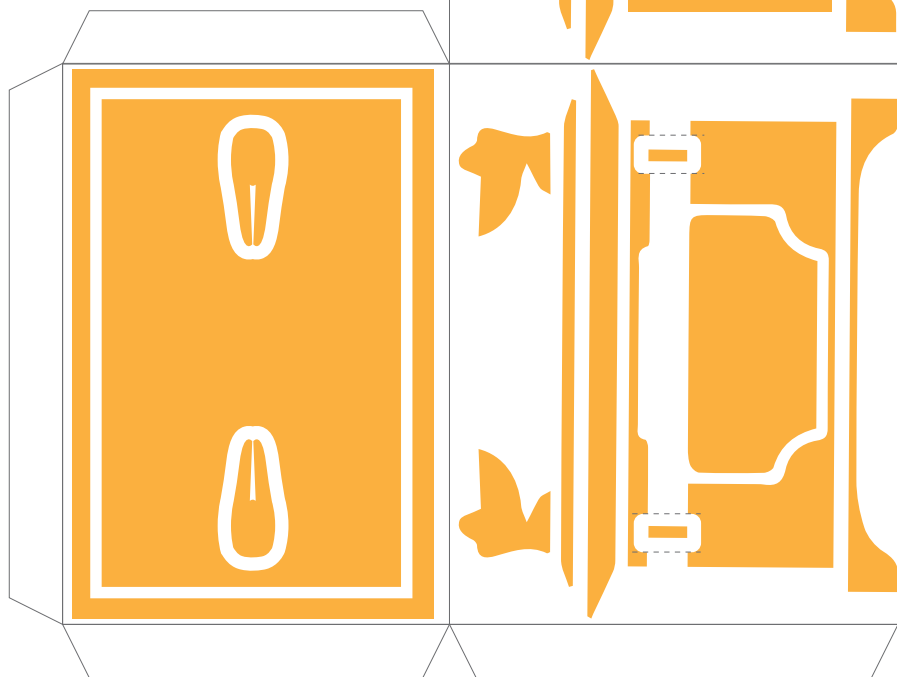

MENORAH

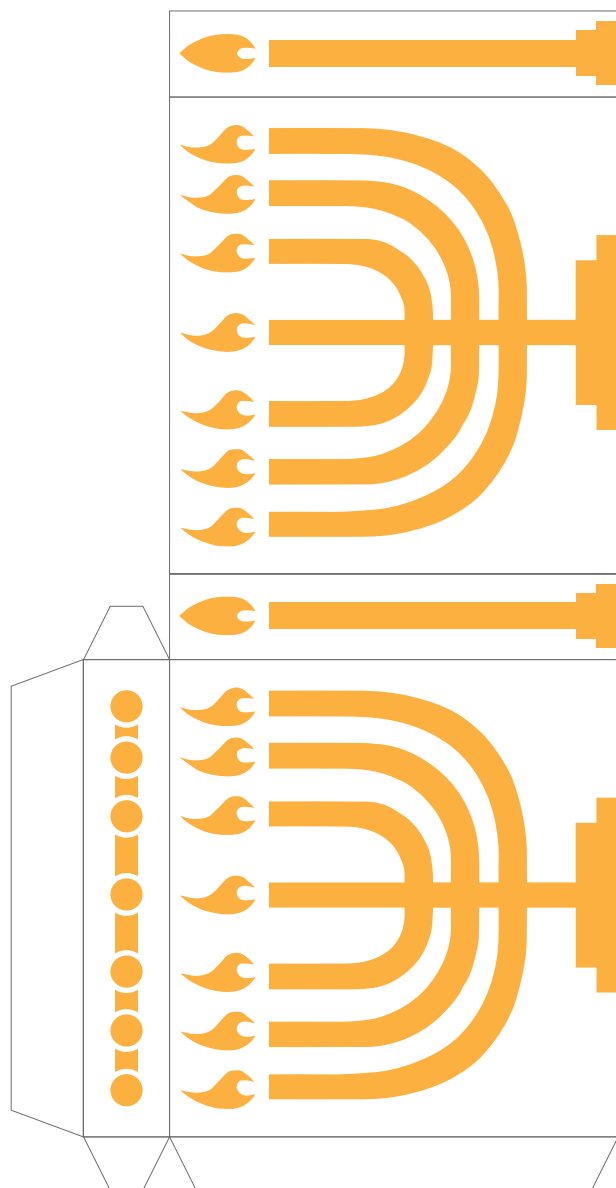

TABLE

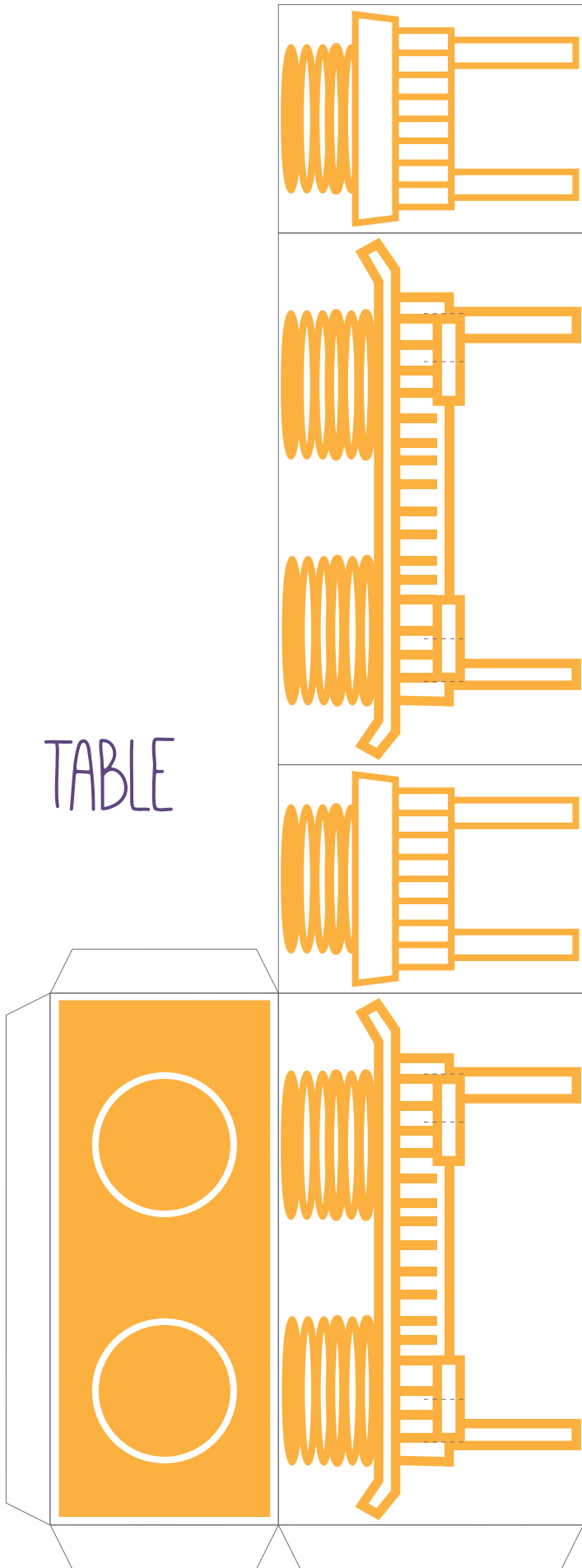

INCENSE ALTER

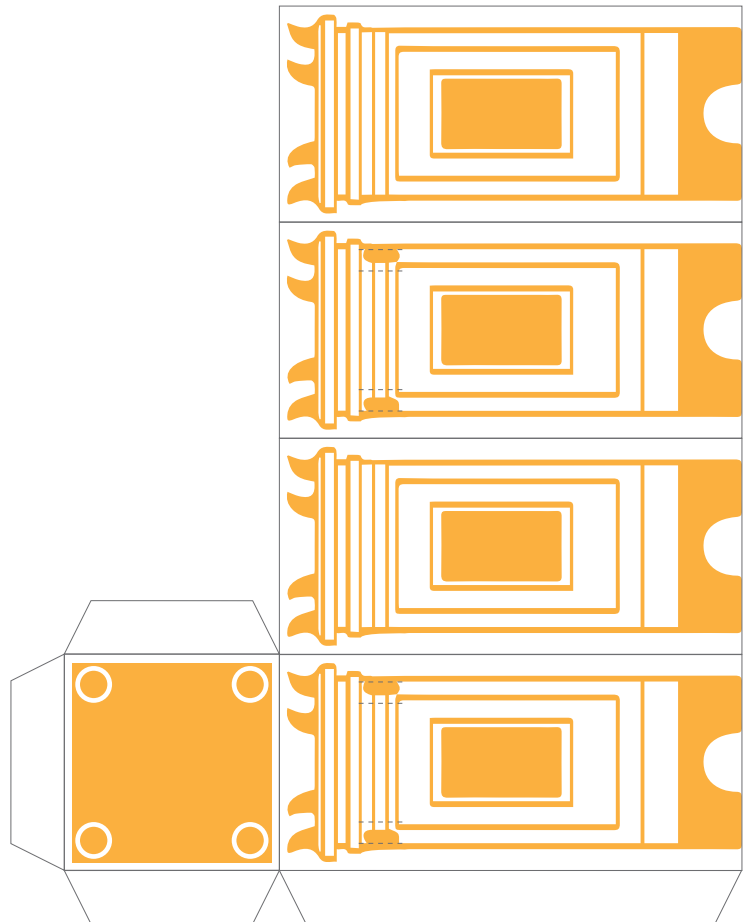

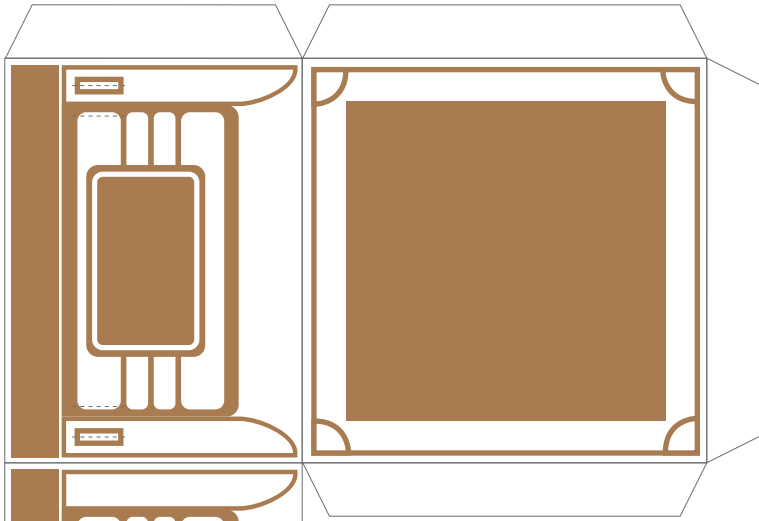

ALTER

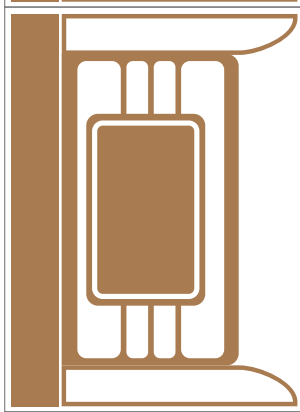
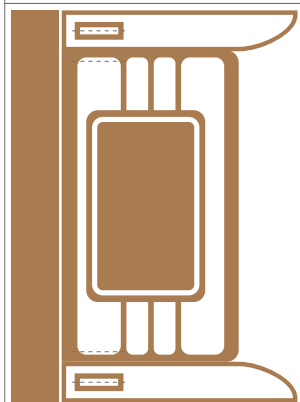
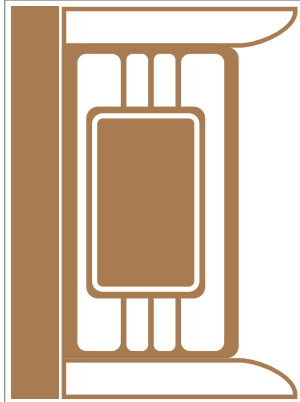

LAYER

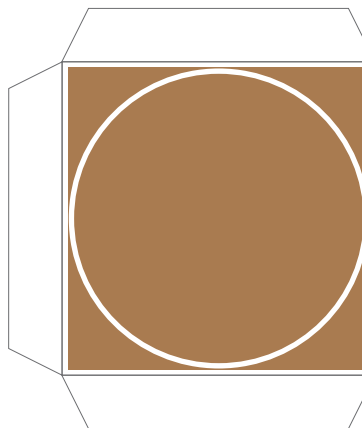

ARK

PRINT ON CARD STOCK & CUT OUT
ON THE OUTSIDE GRAY LINE

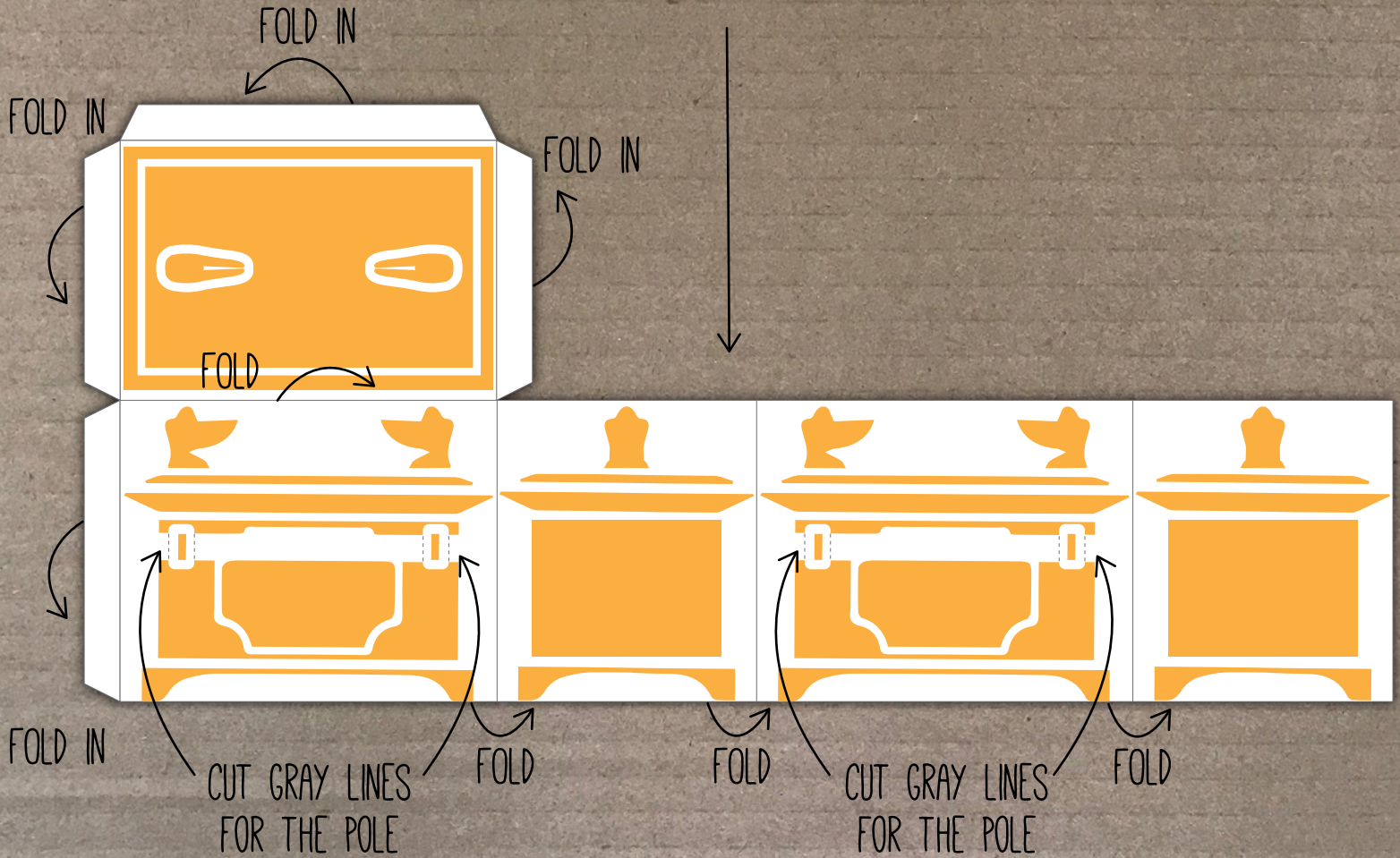

FOLD TO FORM A BOX & GLUE THE FLAPS
ONTO THE EDGES TO FORM A BOX

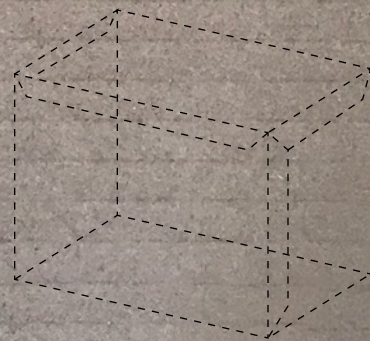

ARK

2 SHEETS OF BLUE & 1 SHEET OF BROWN CONSTRUCTION PAPER

1 .125IN X
12IN DOWEL

X2

CUT IN
HALF

COLORS BASED OFF OF NUMBERS 4:5-6

ARK

USE THE LARGE BLUE TEMPLATE TO CUT THE BLUE PAPER

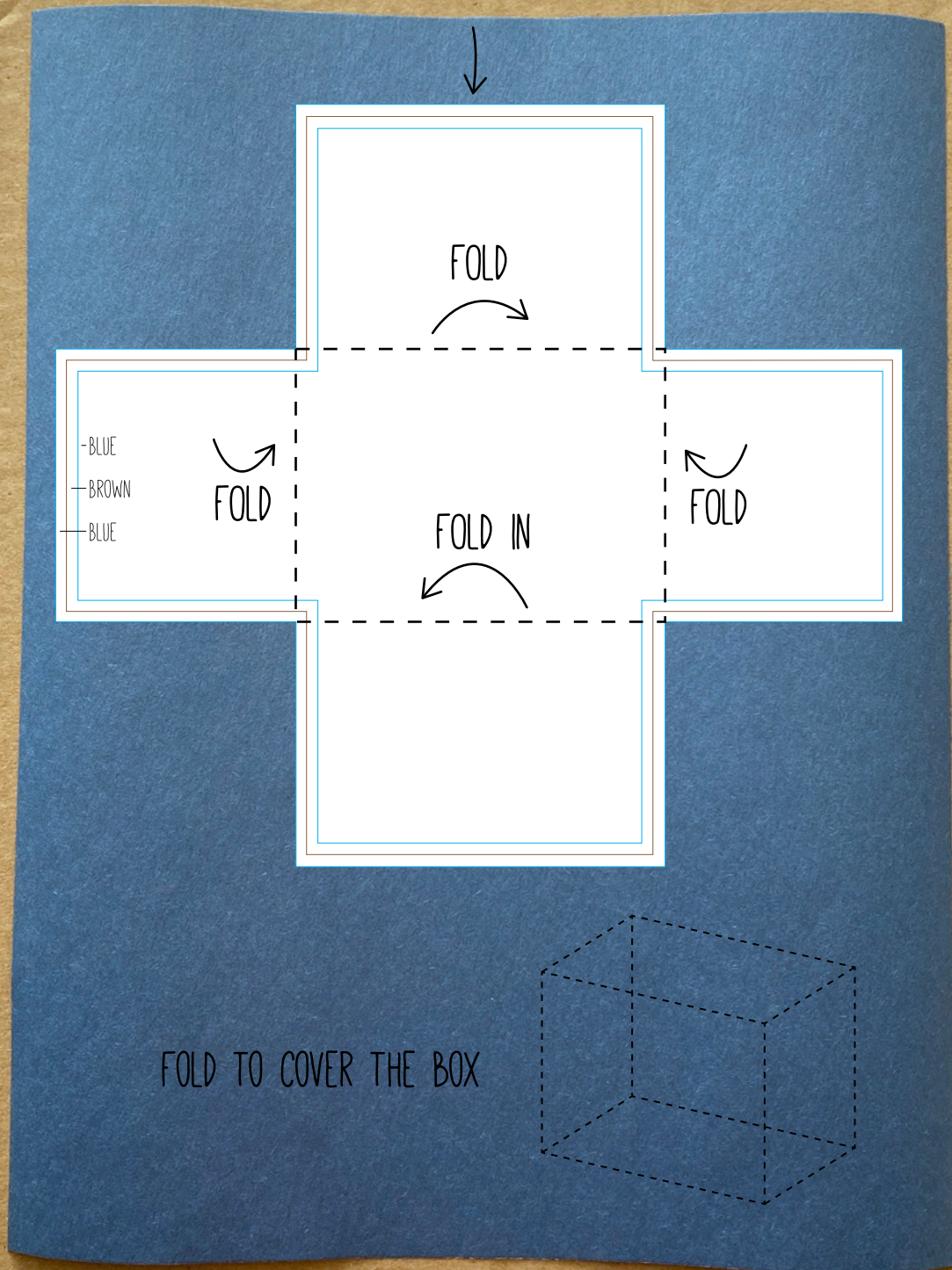

REPEAT CUTTING THE TEMPLATE FOR THE BROWN & BLUE PAPER WITH THE BROWN & BLUE LINES
FOR ACTIVITY 3 LAYER THE PAPER ON TOP OF ARK: BLUE, BROWN THEN BLUE

ARK

CUT OUT THE BLUE TEMPLATE/PAPER FIRST

BROWN TEMPLATE/PAPER SECOND

BLUE TEMPLATE/PAPER THIRD

SO THE PAPER CAN LAYER ON TOP OF EACH OTHER

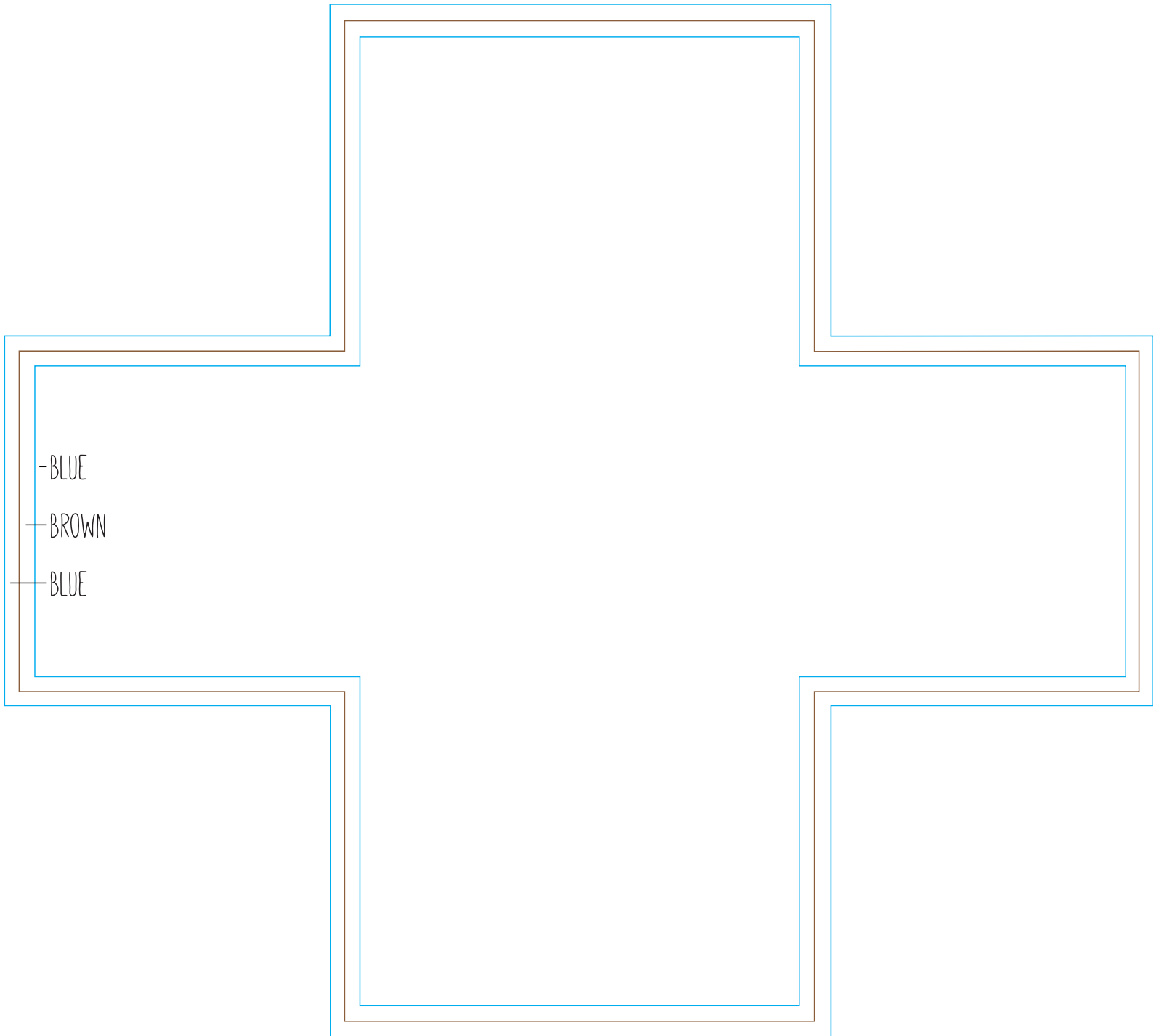

ARK

INSERT THE .125IN X 6IN
DOWELS INTO THE SLITS

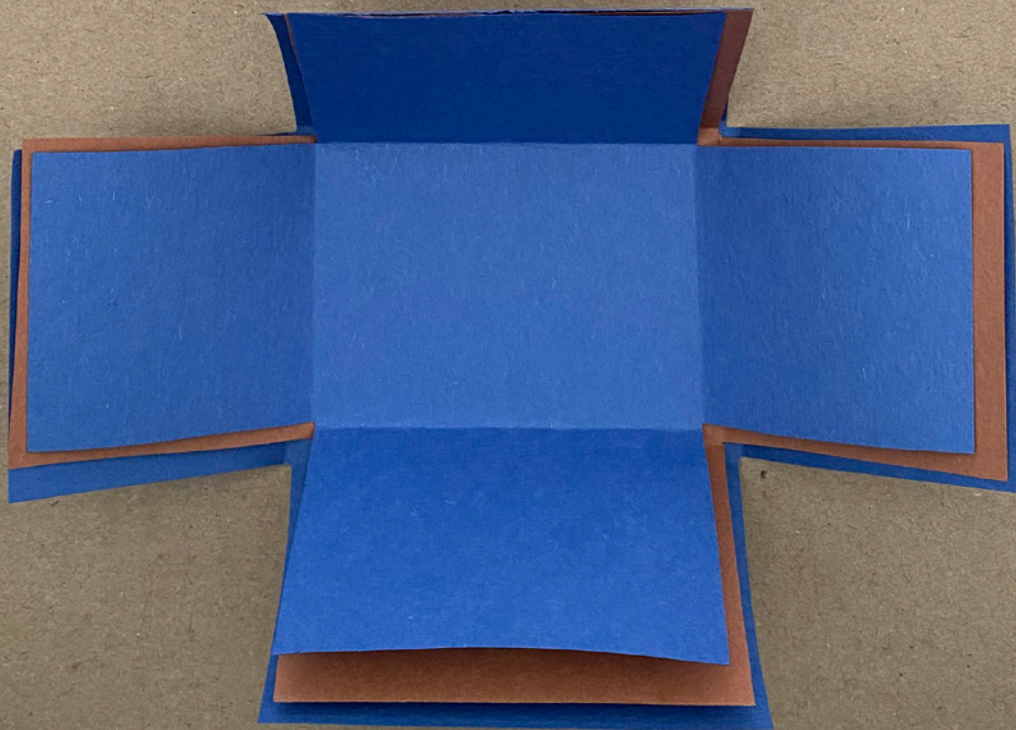

FOLD & LAYER THE BLUE, BROWN & BLUE PAPER

ARK

PLACE THE LAYERED BLUE, BROWN & BLUE PAPER ON
TOP OF THE ARK SO IT IS READY TO MOVE



INCENSE ALTER

PRINT ON CARD STOCK & CUT OUT
ON THE OUTSIDE GRAY LINE

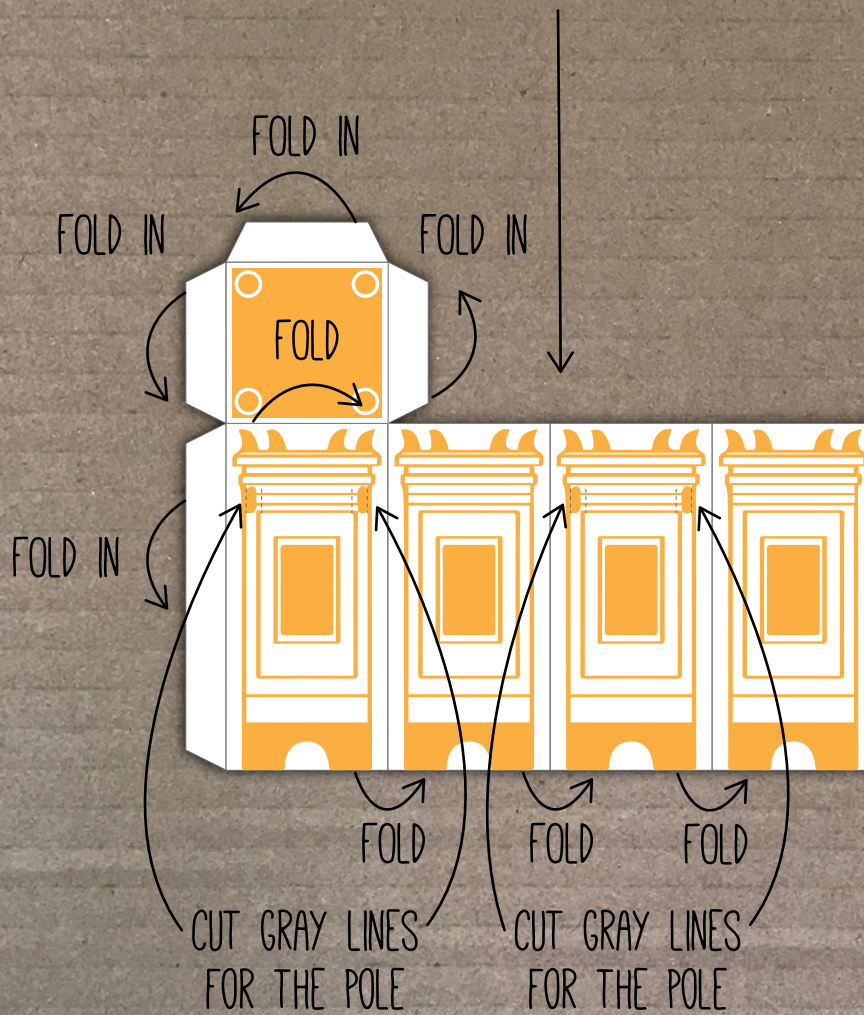

FOLD TO FORM A BOX & GLUE THE FLAPS
ONTO THE EDGES TO FORM A BOX

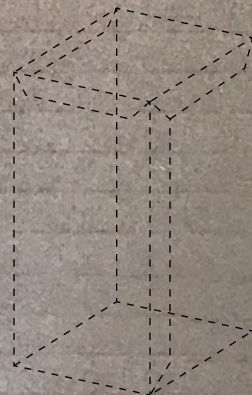

INCENSE ALTER

1 SHEET OF BLUE & BROWN CONSTRUCTION PAPER



1 .125IN X
12IN DOWEL

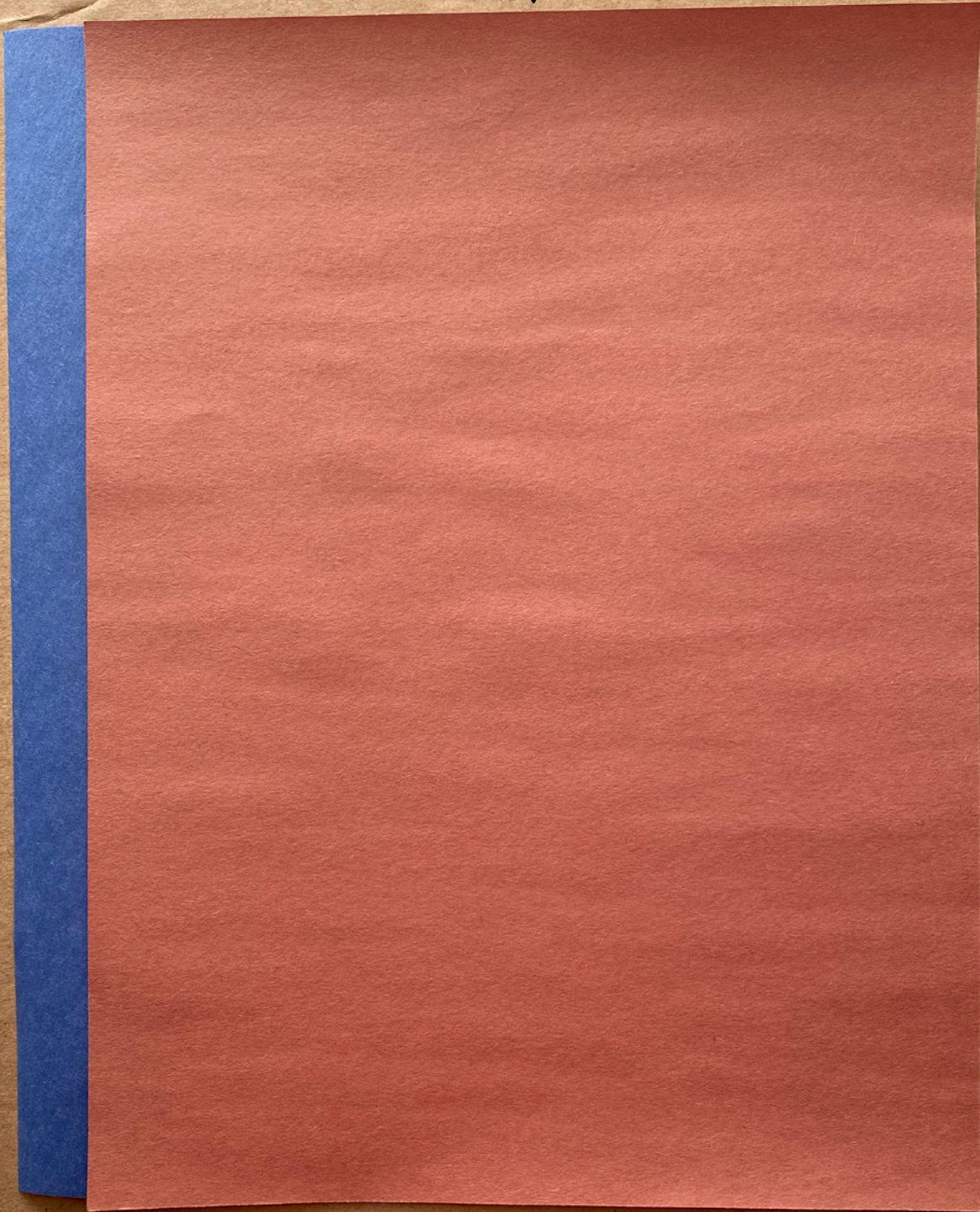

CUT IN
HALF



COLORS BASED OFF OF NUMBERS 4:11

INCENSE ALTER

USE THE BROWN TEMPLATE TO CUT THE BROWN PAPER

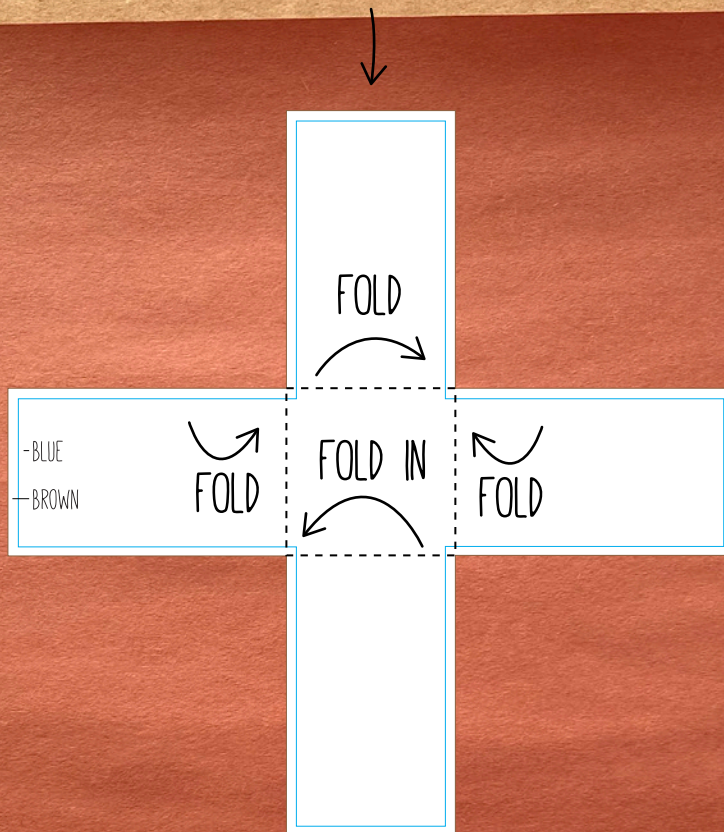

FOLD TO COVER THE BOX

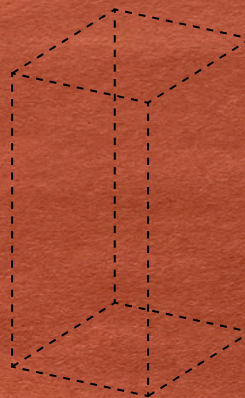

REPEAT CUTTING THE TEMPLATE FOR THE BLUE PAPER WITH THE BLUE LINE
FOR ACTIVITY 3 LAYER THE PAPER ON TOP OF INCENSE ALTER: BLUE THEN BROWN

INCENSE ALTER

CUT OUT THE BROWN TEMPLATE/PAPER FIRST

BLUE TEMPLATE/PAPER SECOND

SO THE PAPER CAN LAYER ON TOP OF EACH OTHER

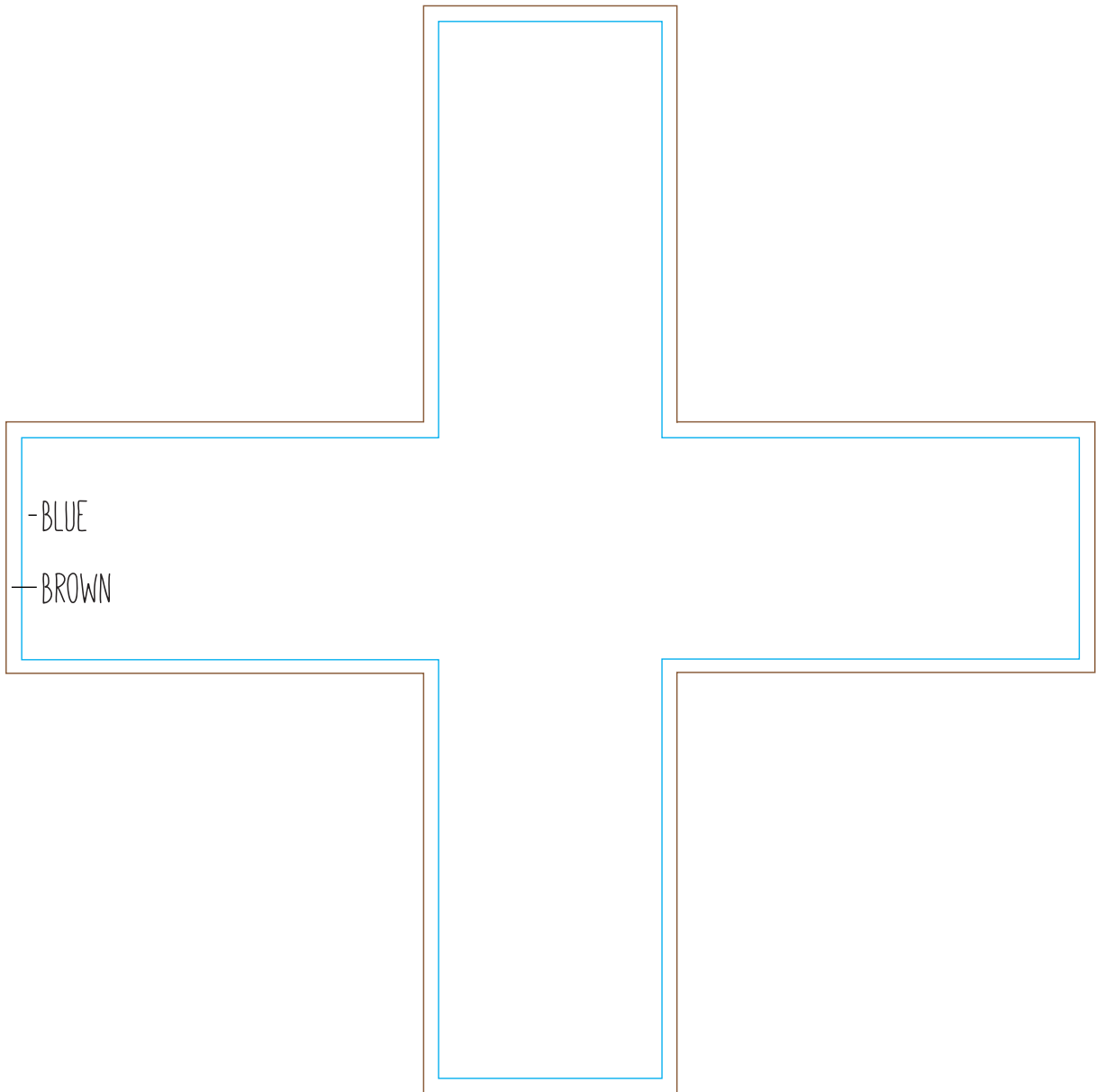

INCENSE ALTER

INSERT THE .125IN X 6IN
DOWELS INTO THE SLITS

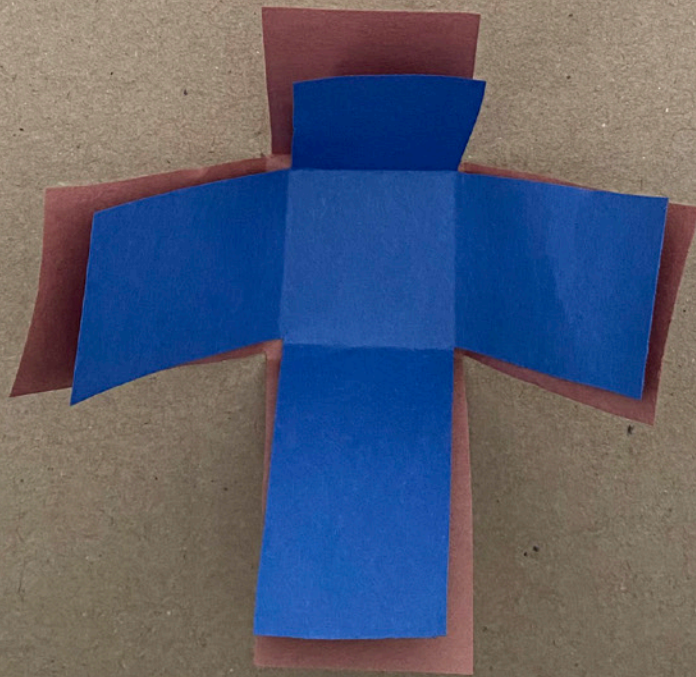
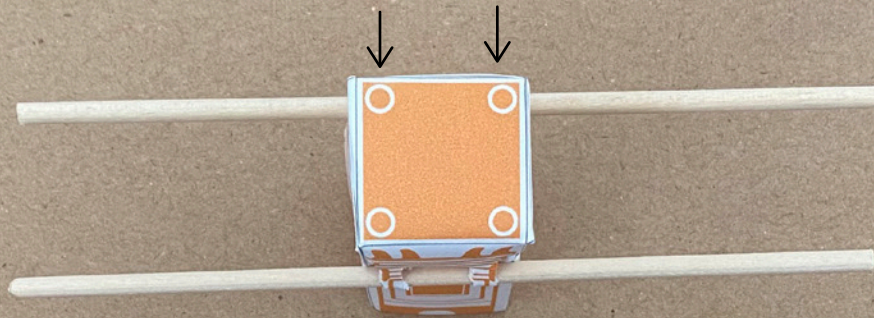

FOLD & LAYER THE BROWN & BLUE PAPER

INCENSE ALTER

PLACE THE LAYERED BROWN & BLUE PAPER ON TOP OF
THE INCENSE ALTER SO IT IS READY TO MOVE

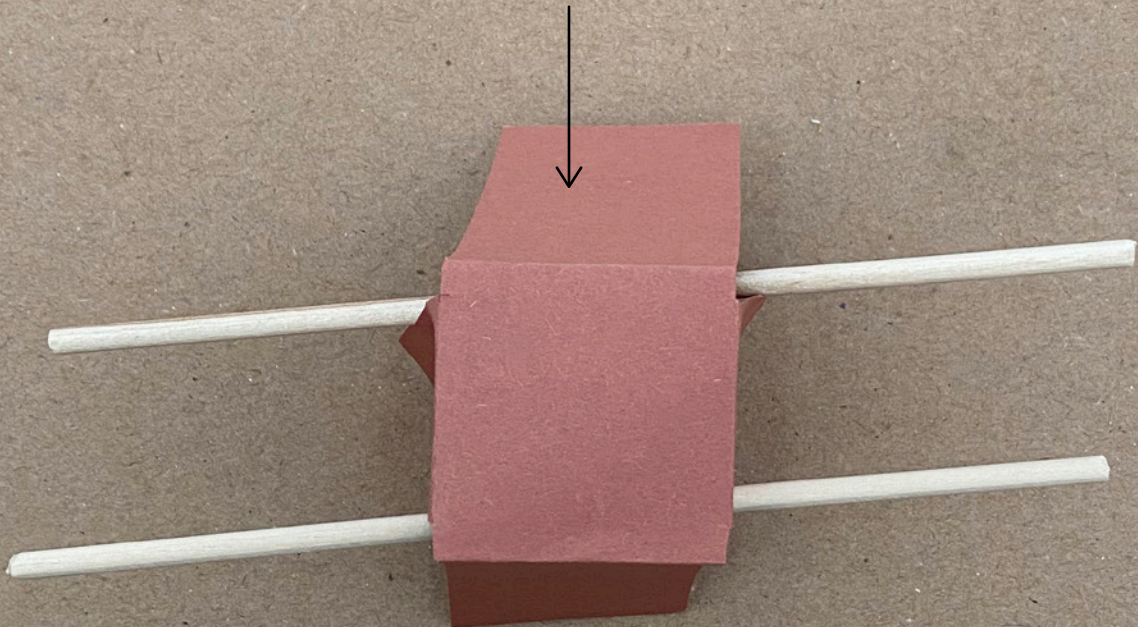

MENORAH

PRINT ON CARD STOCK & CUT OUT
ON THE OUTSIDE GRAY LINE

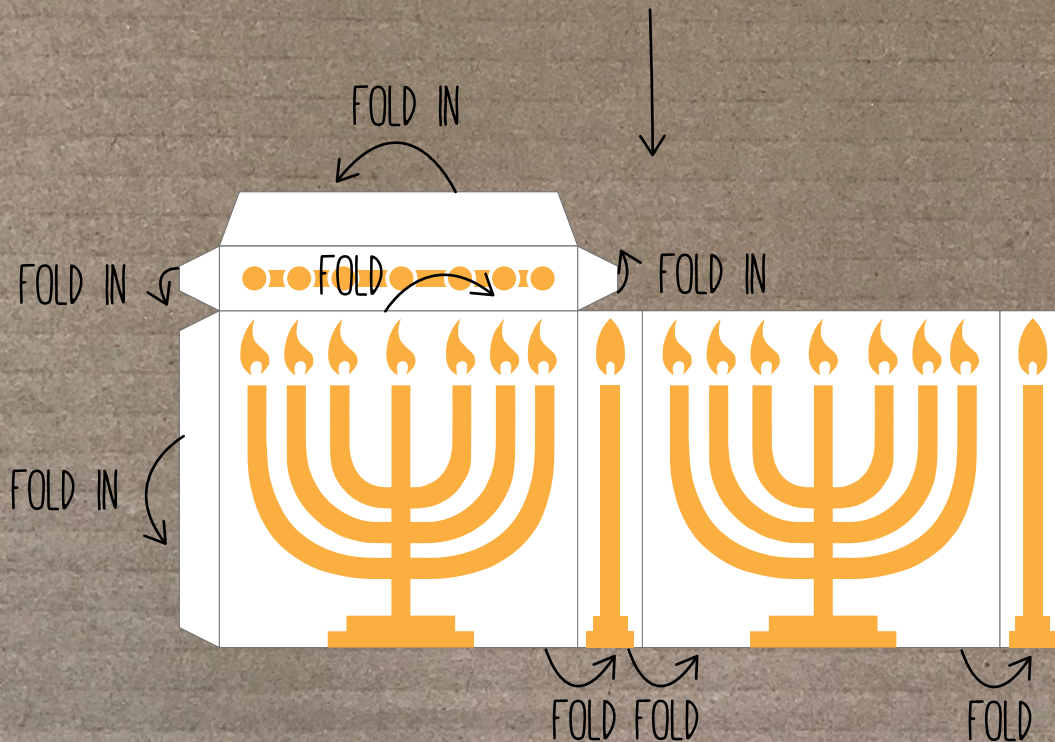

FOLD TO FORM A BOX & GLUE THE FLAPS
ONTO THE EDGES TO FORM A BOX

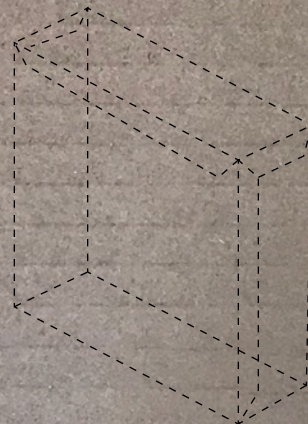

MENORAH

1 SHEET OF BLUE & BROWN CONSTRUCTION PAPER

2 .125IN X
12IN DOWELS

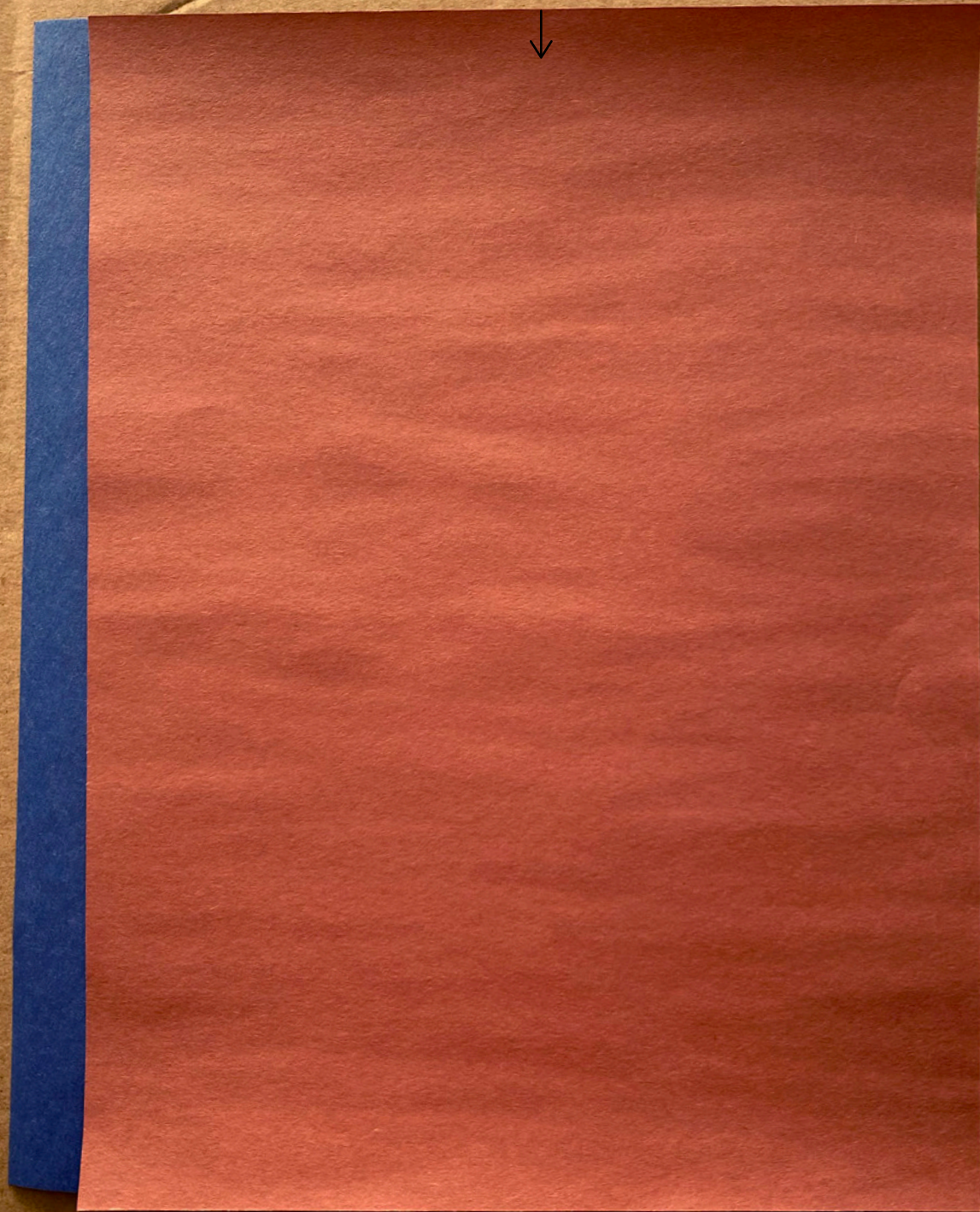

CUT IN
HALF

COLORS BASED OFF OF NUMBERS 4:9-10

MENORAH

USE THE BROWN TEMPLATE TO CUT THE BROWN PAPER

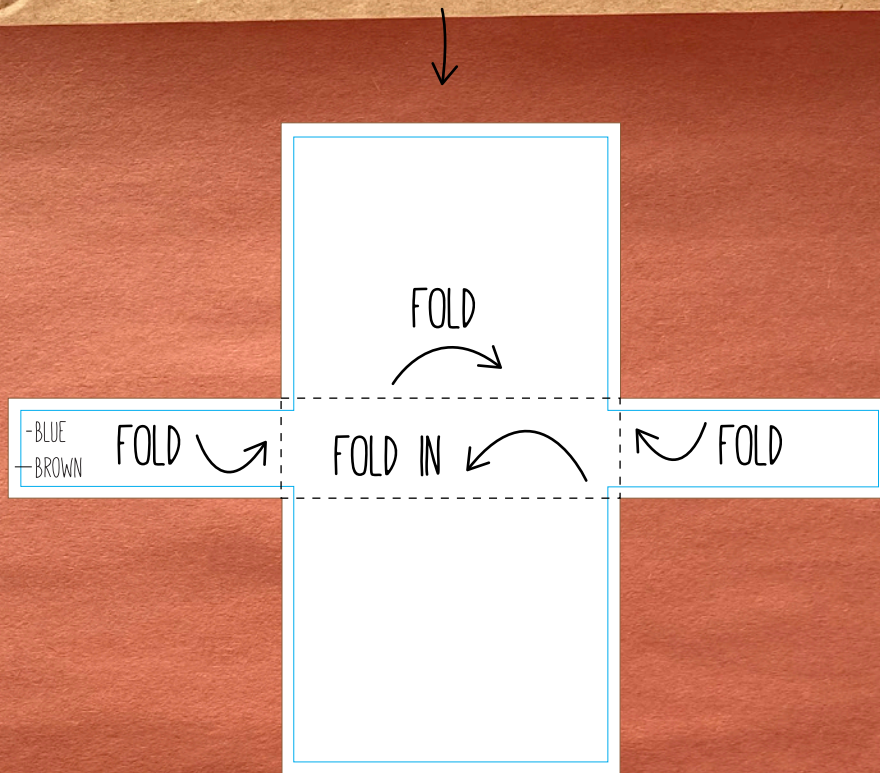

FOLD TO COVER THE BOX

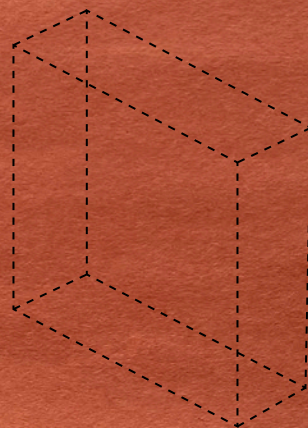

REPEAT CUTTING THE TEMPLATE FOR THE BLUE PAPER WITH THE BLUE LINE
FOR ACTIVITY 3 LAYER THE PAPER ON TOP OF MENORAH: BLUE THEN BROWN

MENORAH

CUT OUT THE BROWN TEMPLATE/PAPER FIRST

BLUE TEMPLATE/PAPER SECOND

SO THE PAPER CAN LAYER ON TOP OF EACH OTHER

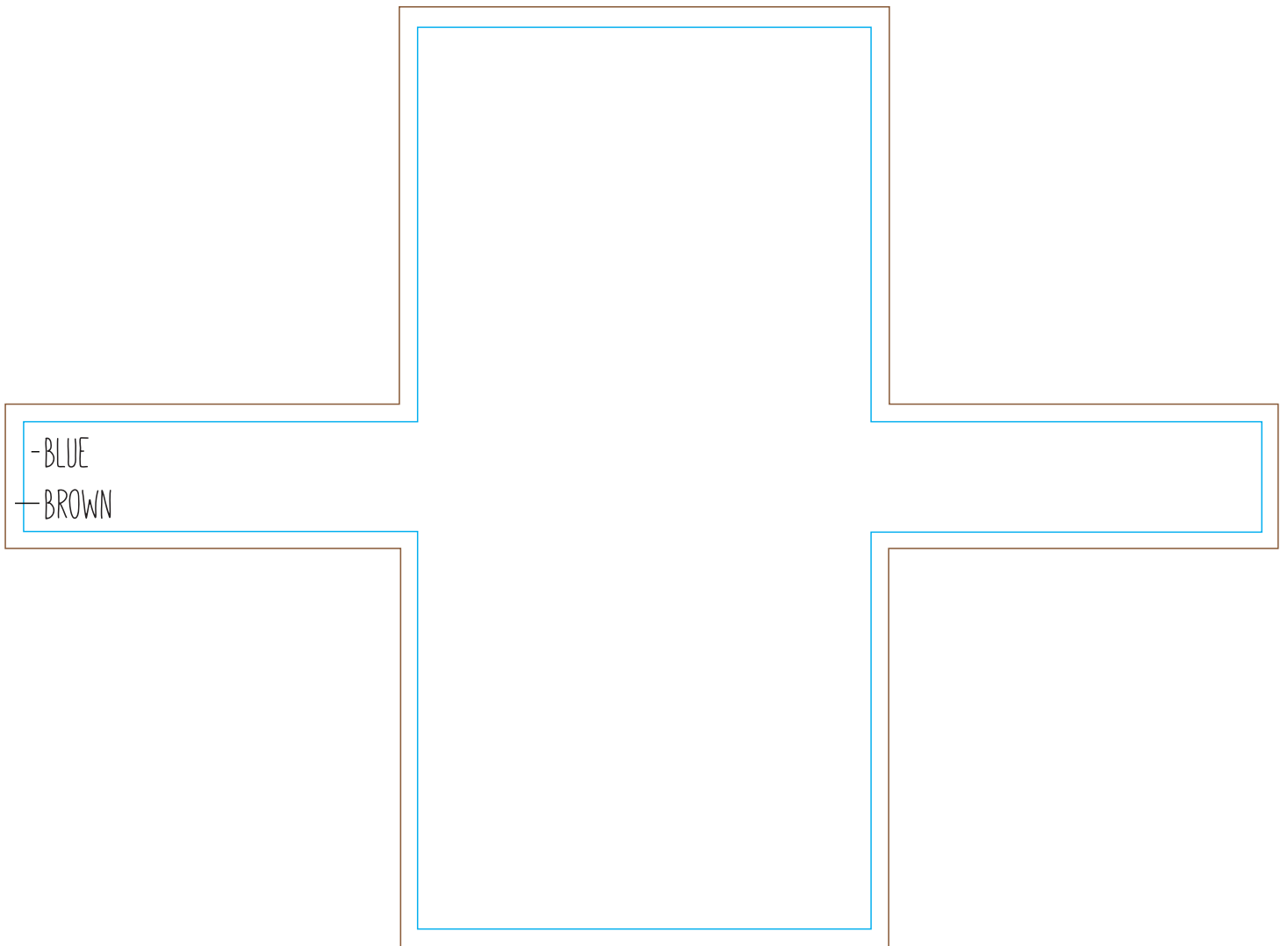

MENORAH

GLUE THE .125IN X 6IN
DOWELS TOGETHER SO
THEY FIT SNUG AROUND
THE MENORAH

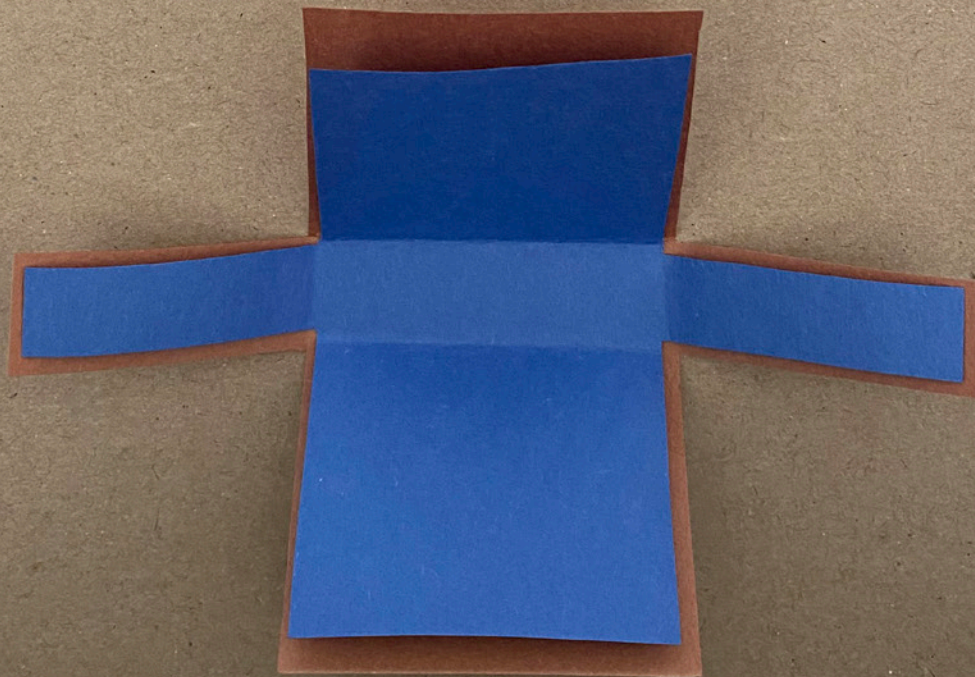
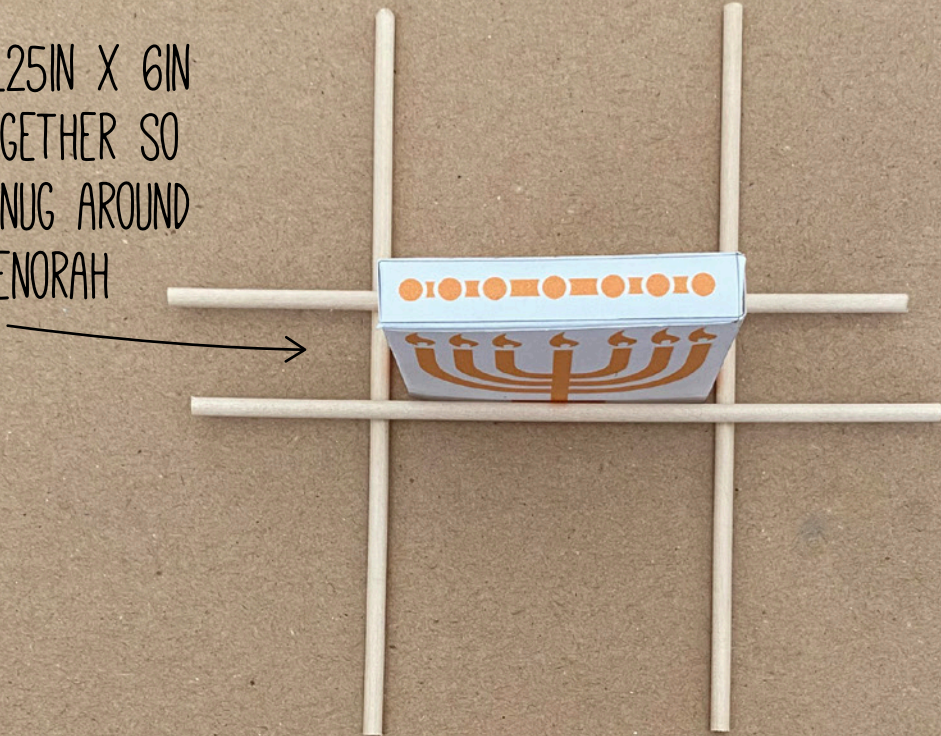

FOLD & LAYER THE BROWN & BLUE PAPER

MENORAH

PLACE THE DOWEL
FRAME & THE LAYERED
BROWN & BLUE PAPER
ON TOP OF THE
MENORAH SO IT IS
READY TO MOVE

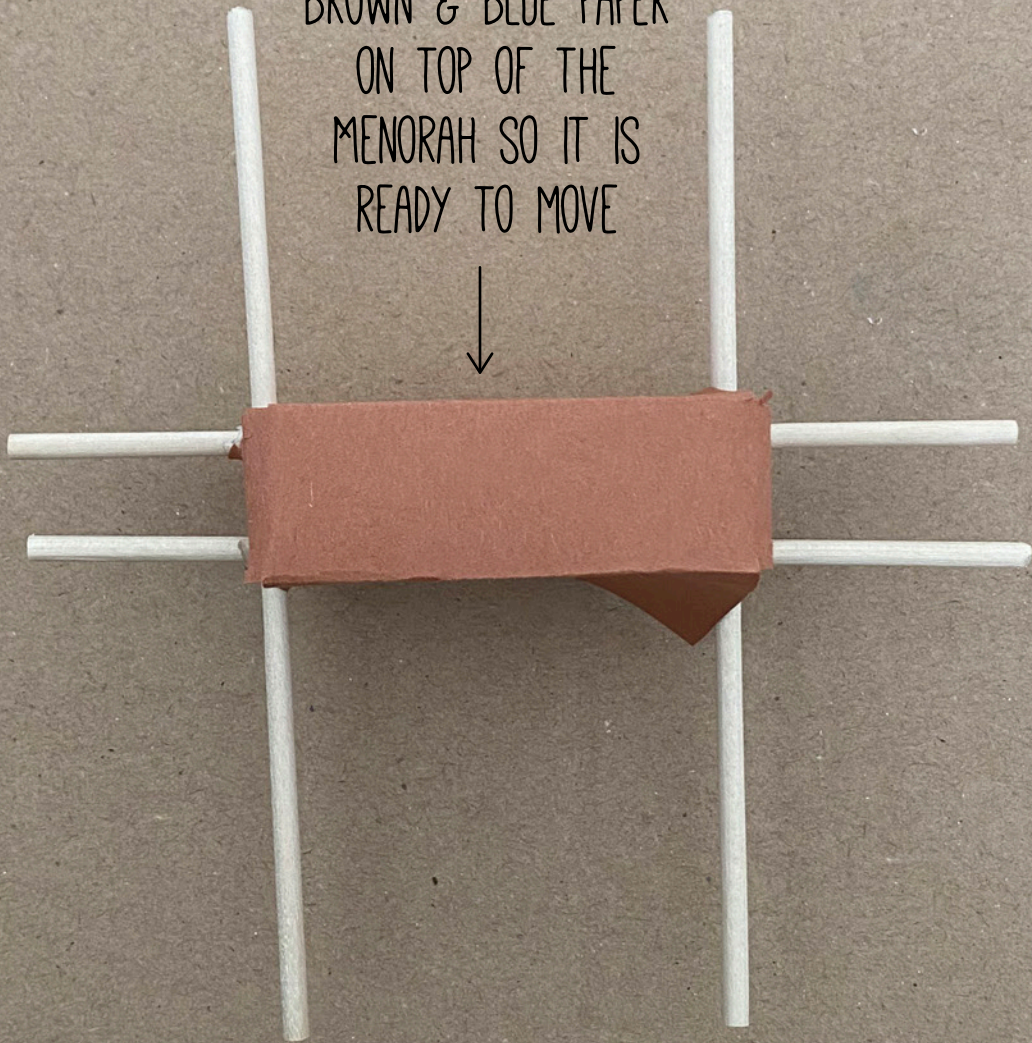
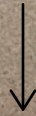

TABLE

PRINT ON CARD STOCK & CUT OUT
ON THE OUTSIDE GRAY LINE

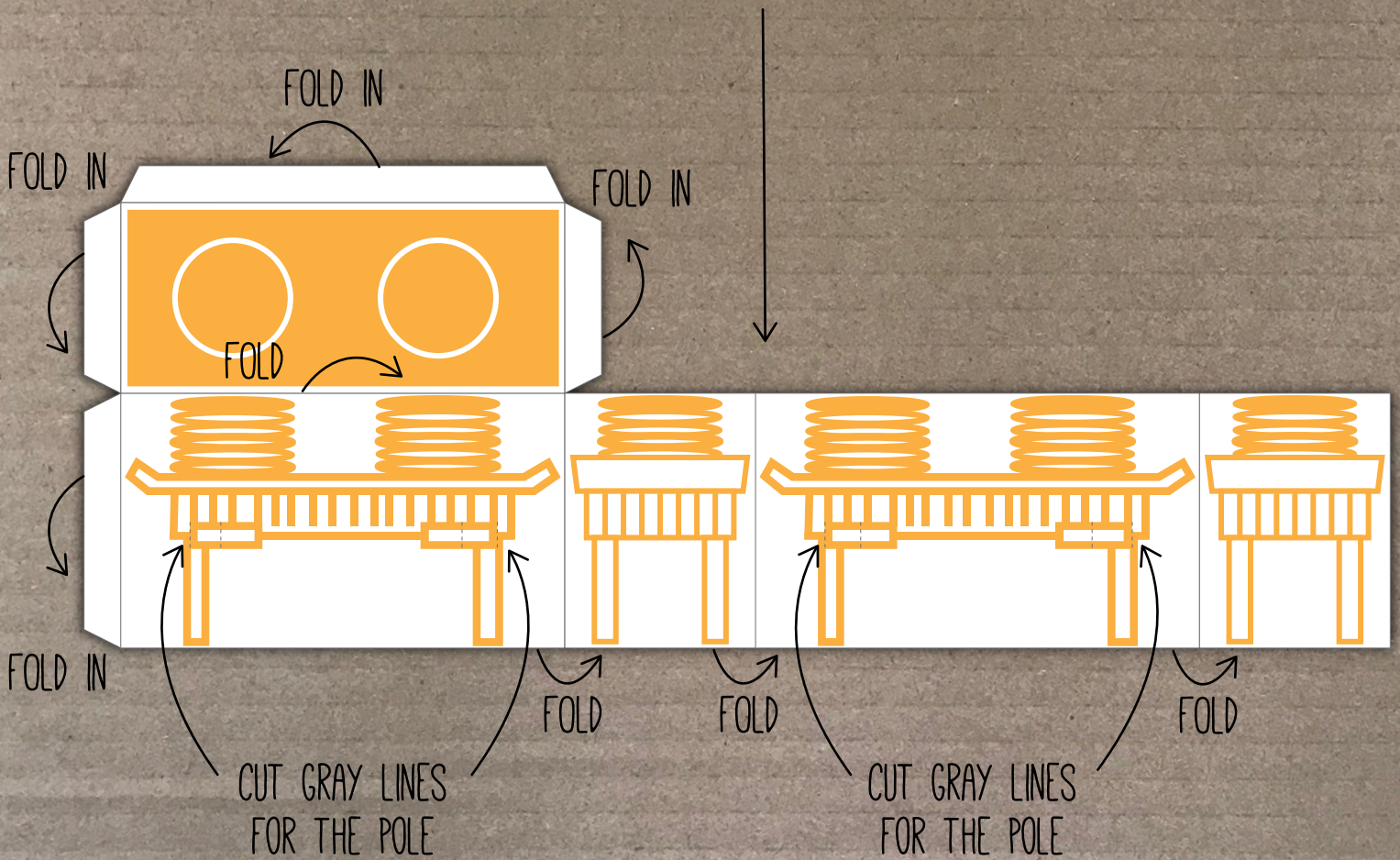

FOLD TO FORM A BOX & GLUE THE FLAPS
ONTO THE EDGES TO FORM A BOX

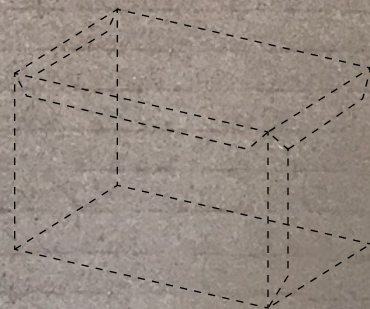

TABLE

1 SHEET OF BLUE, RED & BROWN CONSTRUCTION PAPER

1 .125IN X
12IN DOWEL



CUT IN
HALF

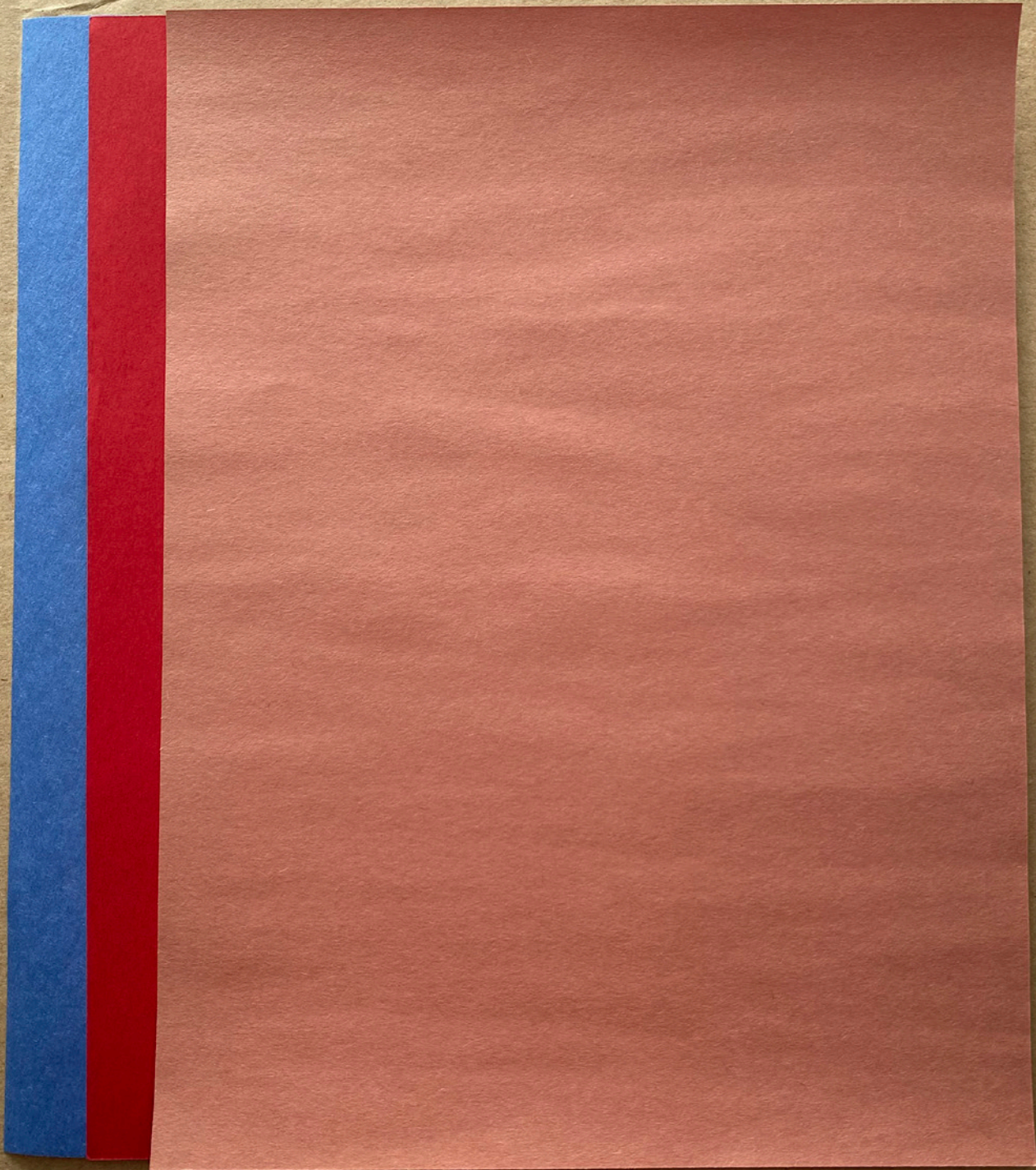

COLORS BASED OFF OF NUMBERS 4:7-8

TABLE

USE THE BROWN TEMPLATE TO CUT THE BROWN PAPER

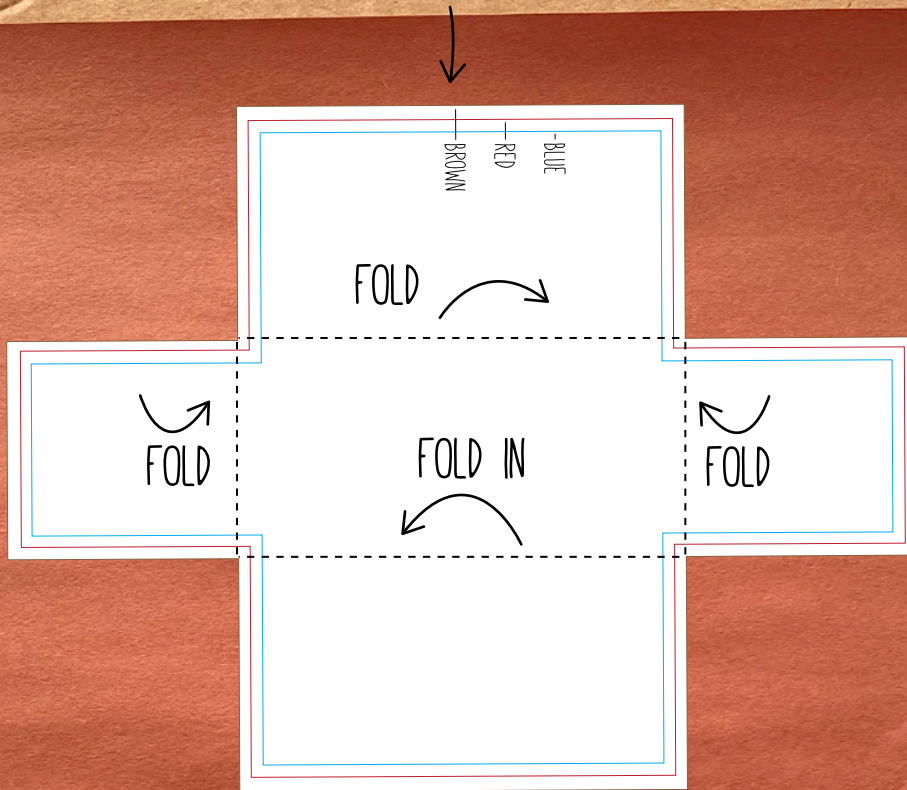

FOLD TO COVER THE BOX

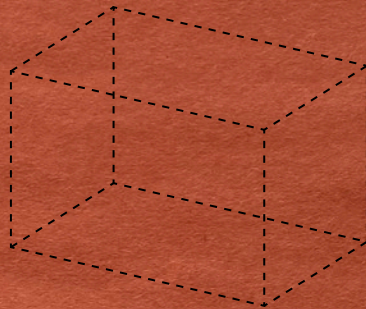

REPEAT CUTTING THE TEMPLATE FOR THE RED & BLUE PAPER WITH THE RED & BLUE LINES
FOR ACTIVITY 3 LAYER THE PAPER ON TOP OF TABLE: BLUE, RED THEN BROWN

TABLE

CUT OUT THE BROWN TEMPLATE/PAPER FIRST

RED TEMPLATE/PAPER SECOND

BLUE TEMPLATE/PAPER THIRD

SO THE PAPER CAN LAYER ON TOP OF EACH OTHER

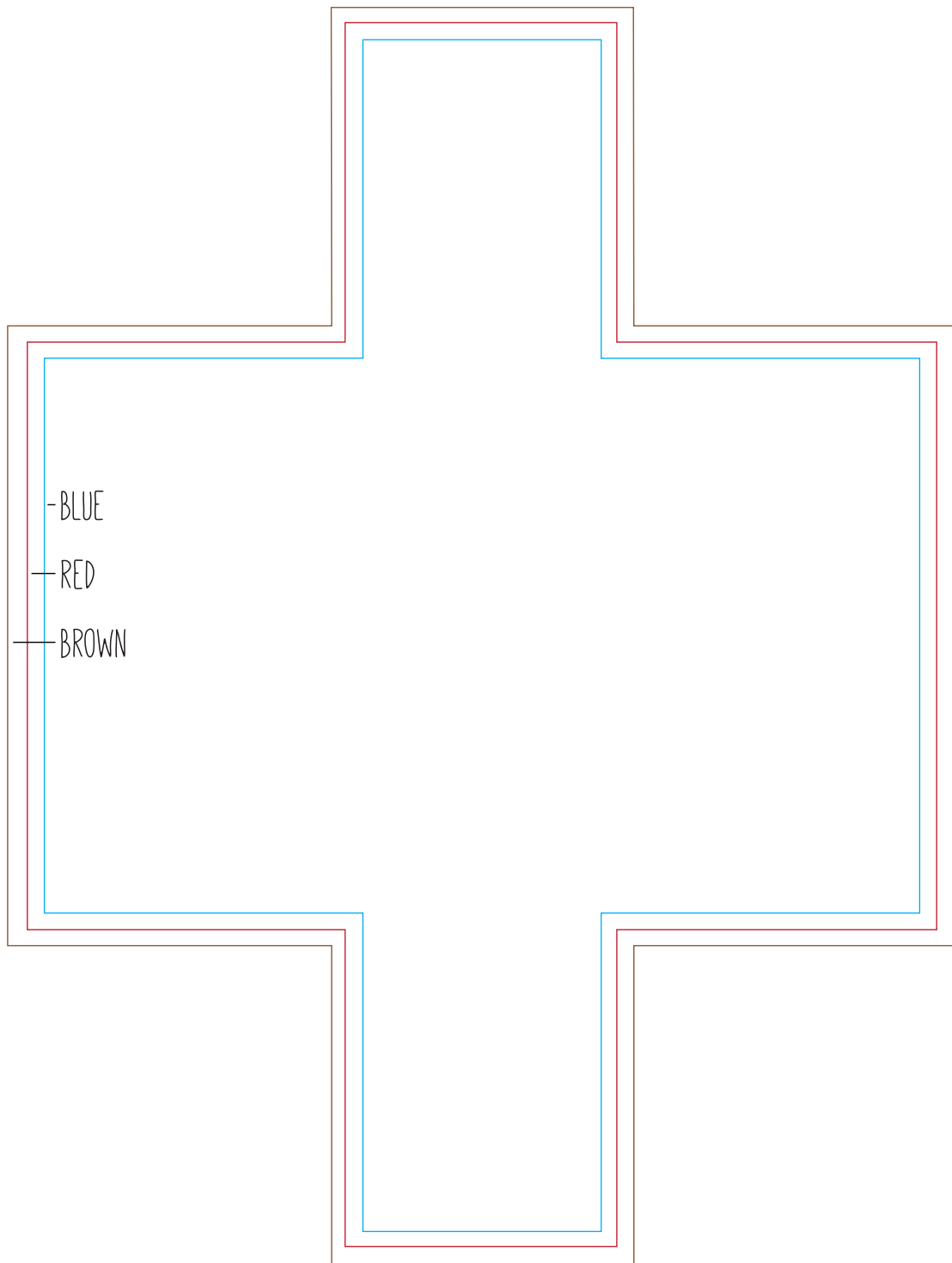

TABLE

INSERT THE .125IN X 6IN
DOWELS INTO THE TABLE SLITS

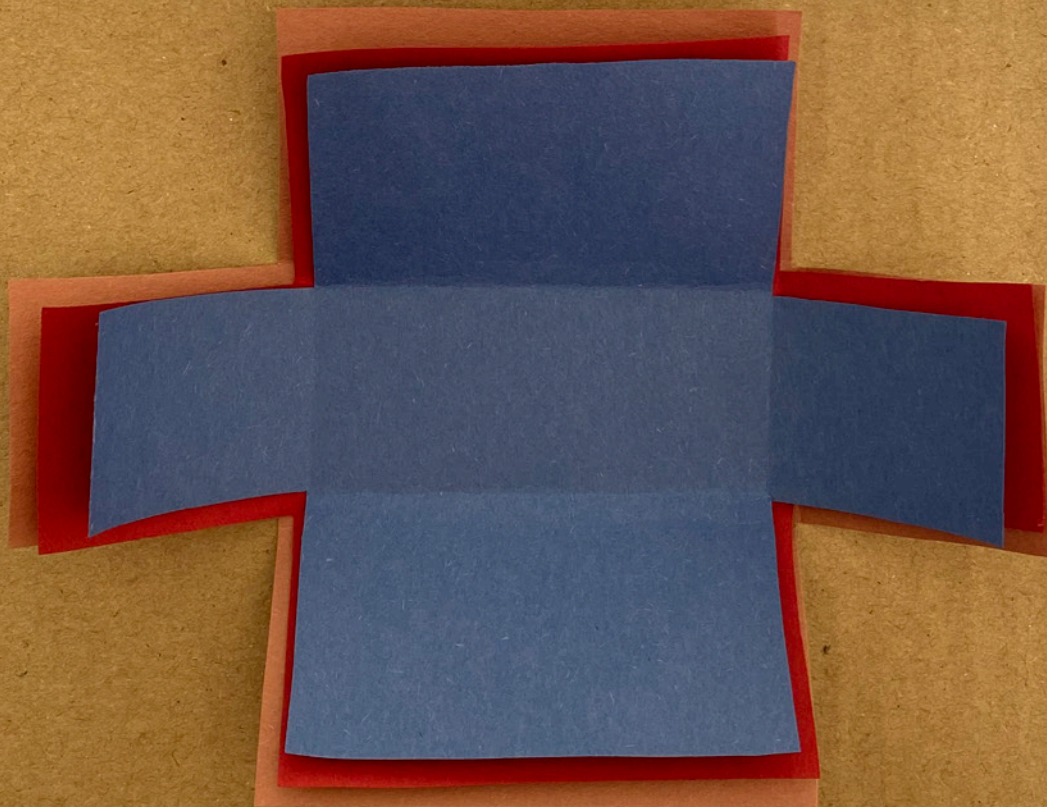
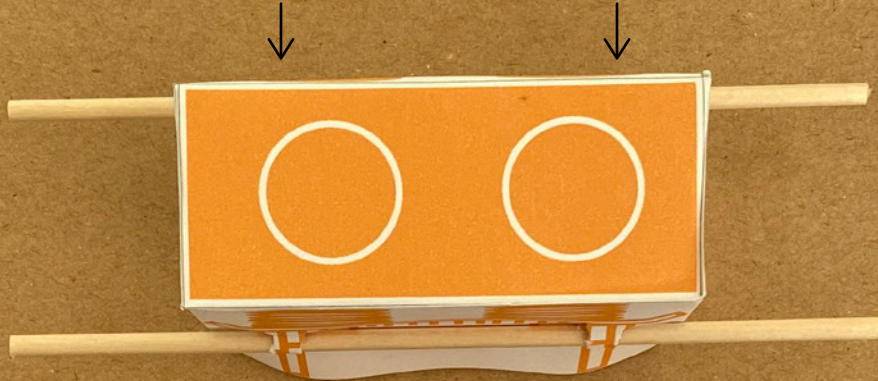

FOLD & LAYER THE BROWN, RED & BLUE PAPER

TABLE

PLACE THE LAYERED BROWN, RED & BLUE PAPER ON
TOP OF THE TABLE SO IT IS READY TO MOVE



LAYER

PRINT ON CARD STOCK & CUT OUT
ON THE OUTSIDE GRAY LINE

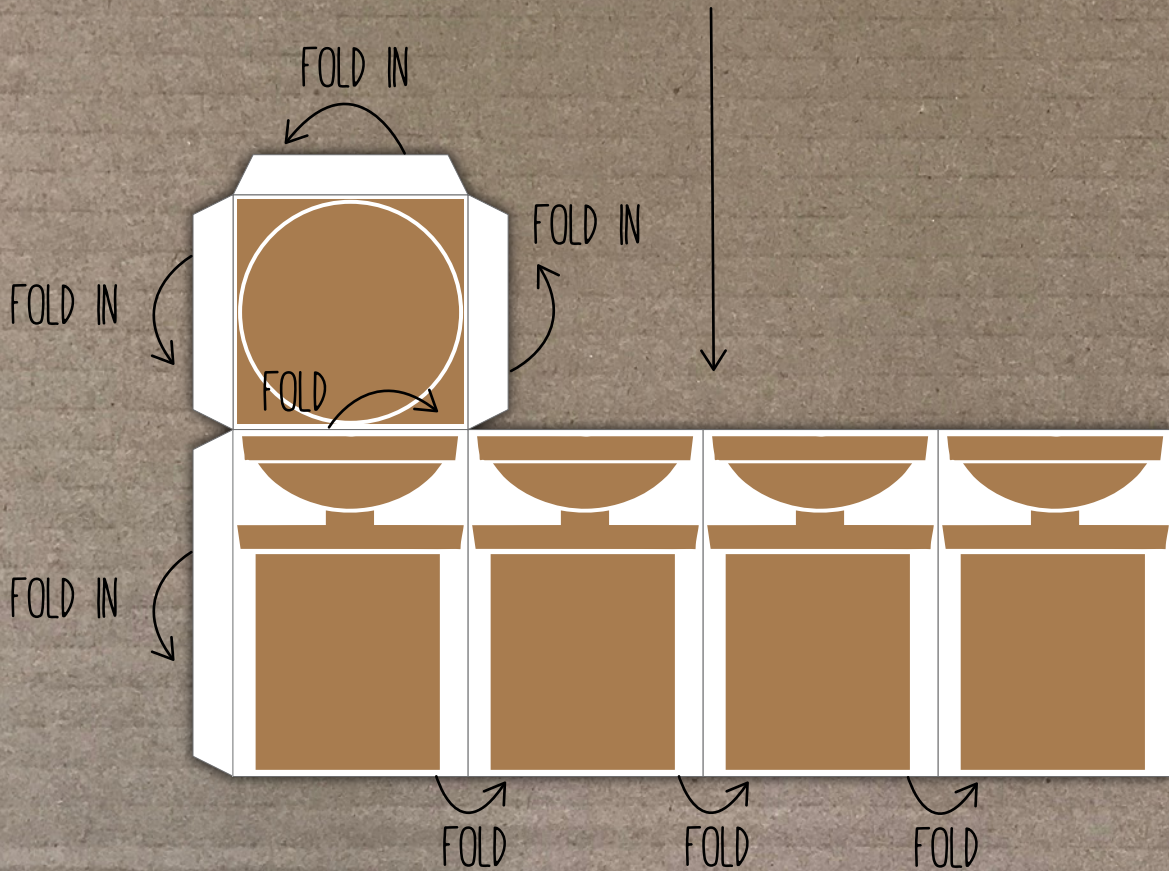

FOLD TO FORM A BOX & GLUE THE FLAPS
ONTO THE EDGES TO FORM A BOX

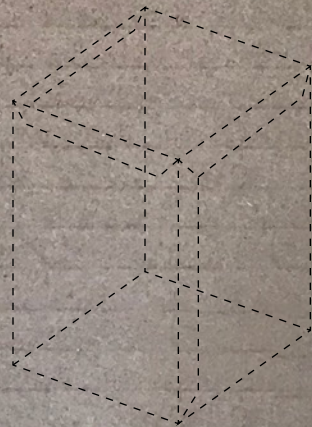

LAYER

1 SHEET OF BLUE & BROWN CONSTRUCTION PAPER

2 .125IN X
12IN DOWELS

CUT IN
HALF

COLORS BASED OFF OF NUMBERS 4:12

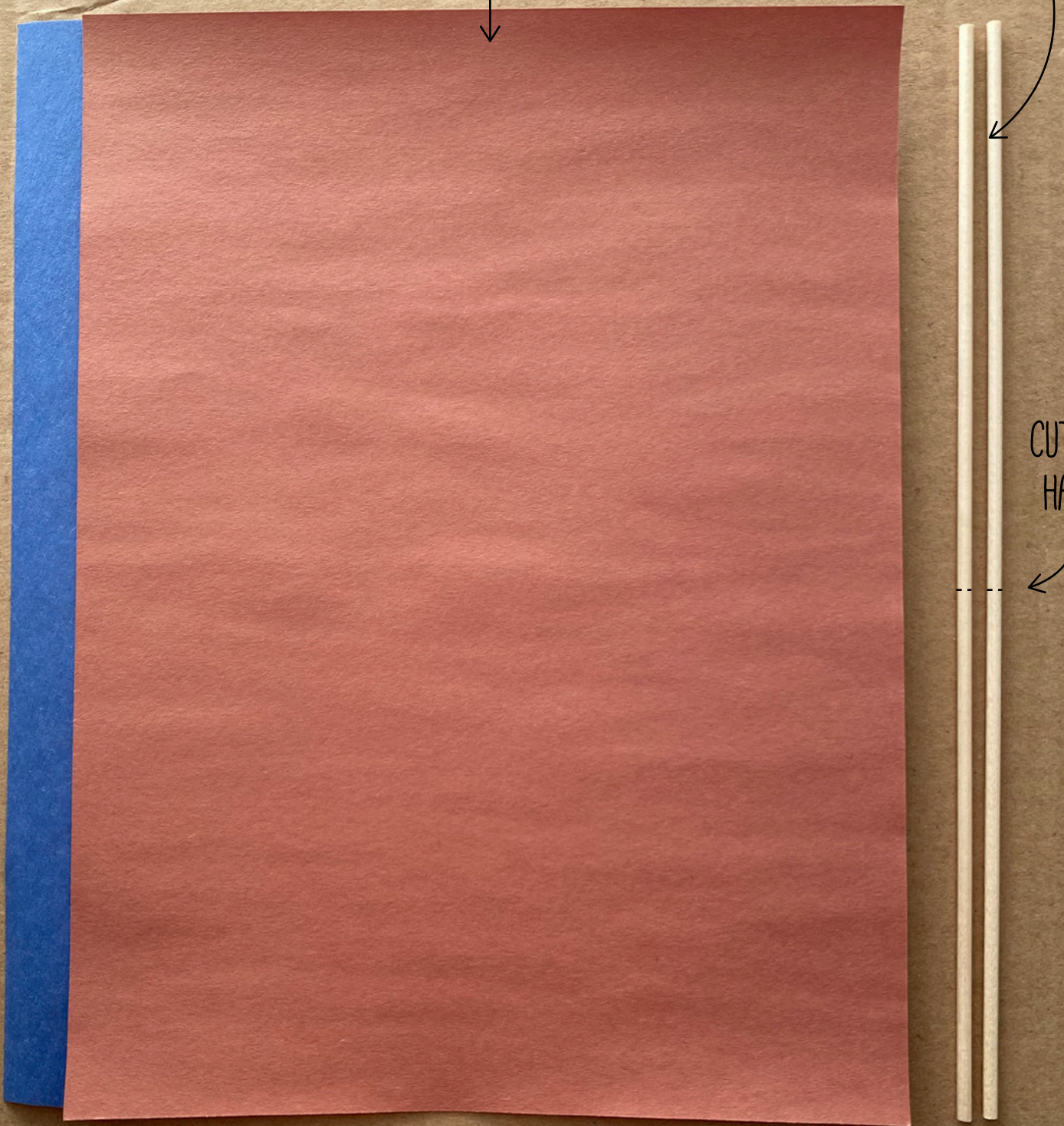

LAYER

USE THE BROWN TEMPLATE TO CUT THE BROWN PAPER

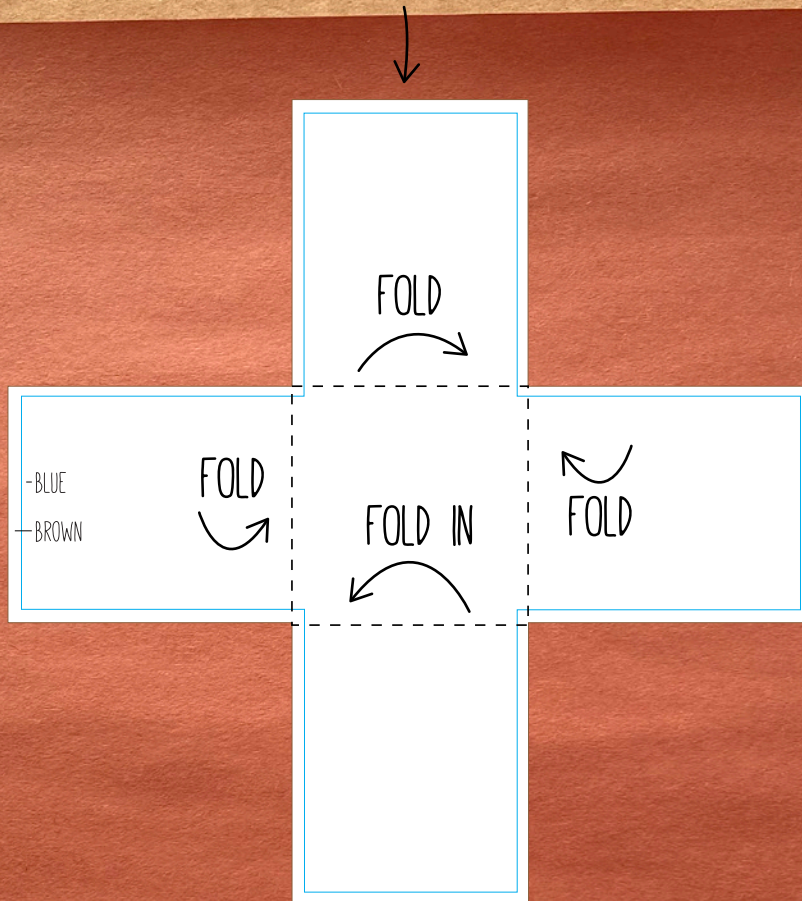

FOLD TO COVER THE BOX

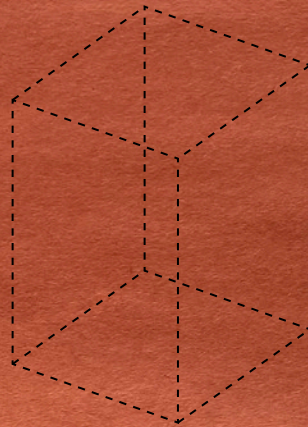

REPEAT CUTTING THE TEMPLATE FOR THE BLUE PAPER WITH THE BLUE LINE
FOR ACTIVITY 3 LAYER THE PAPER ON TOP OF LAYER: BLUE THEN BROWN

LAYER

CUT OUT THE BROWN TEMPLATE/PAPER FIRST

BLUE TEMPLATE/PAPER SECOND

SO THE PAPER CAN LAYER ON TOP OF EACH OTHER

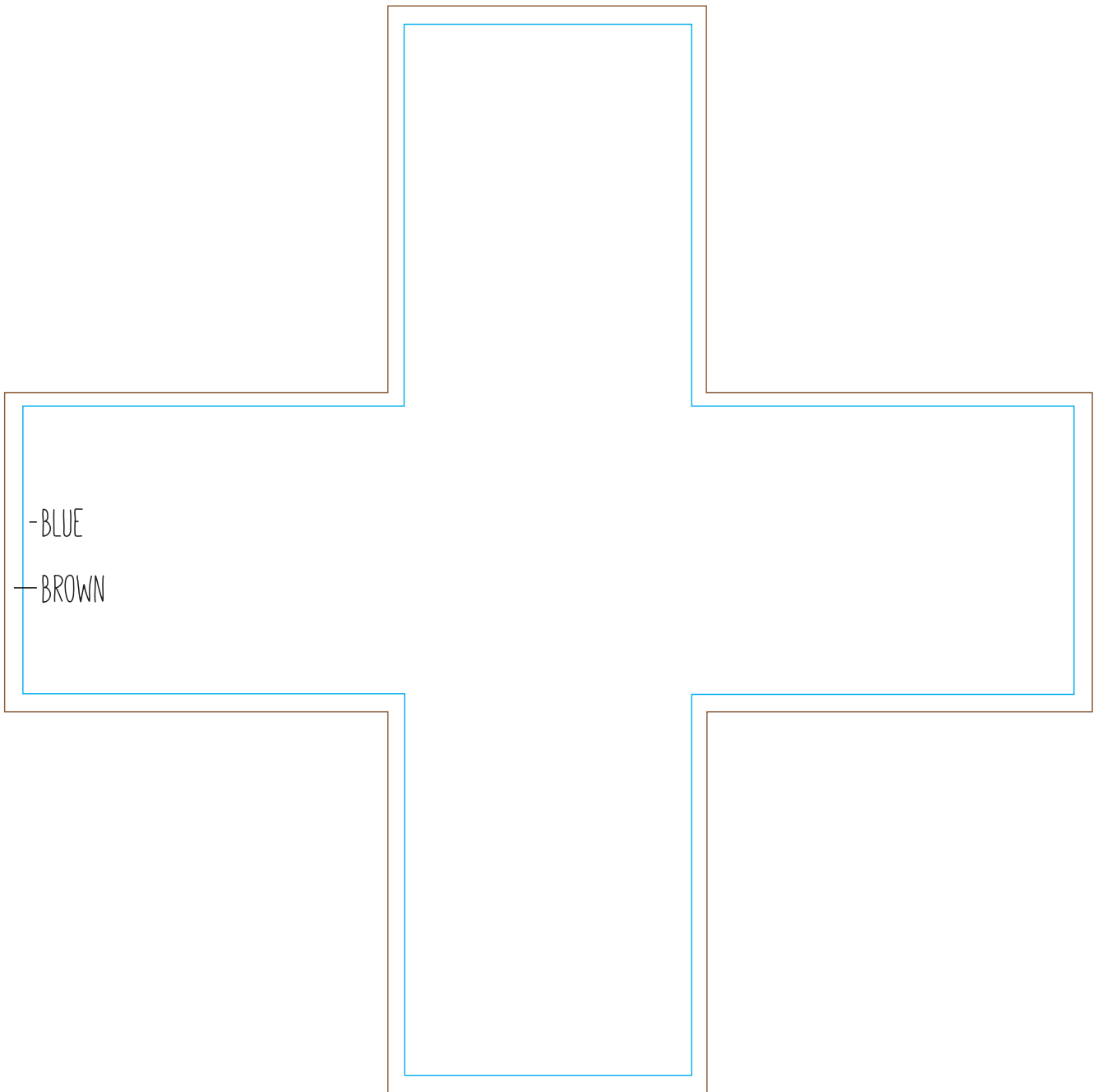

LAVER

GLUE THE .125IN X 6IN
DOWELS TOGETHER SO
THEY FIT SNUG AROUND
THE LAVER

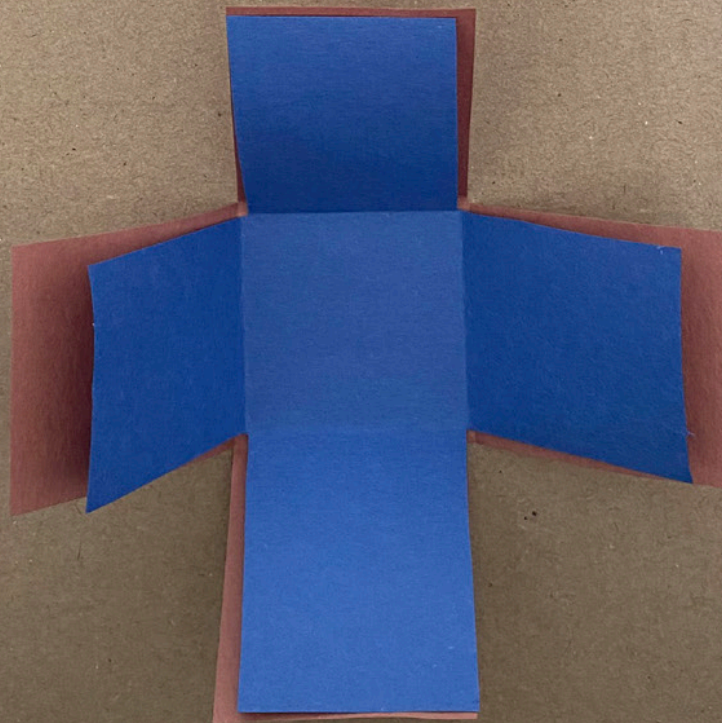
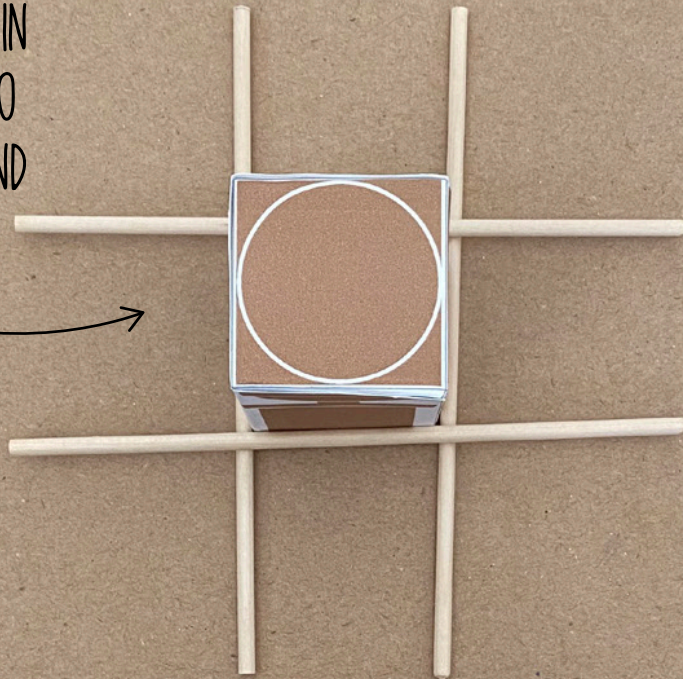
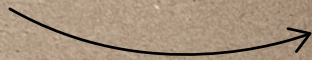

FOLD & LAYER THE BROWN & BLUE PAPER

LAYER

PLACE THE DOWEL
FRAME & THE LAYERED
BROWN & BLUE PAPER
ON TOP OF THE
LAYER SO IT IS READY
TO MOVE

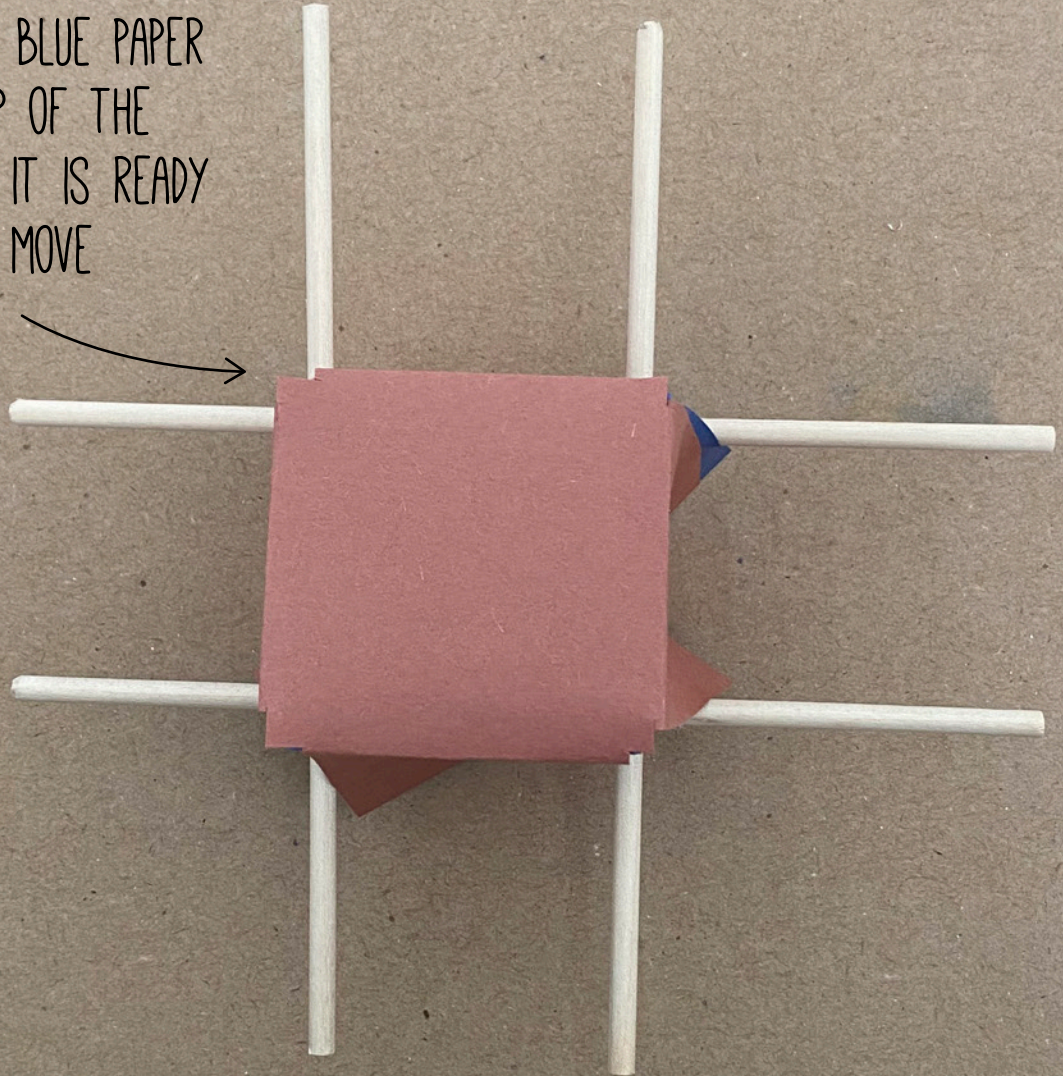

ALTER

PRINT ON CARD STOCK & CUT OUT
ON THE OUTSIDE GRAY LINE

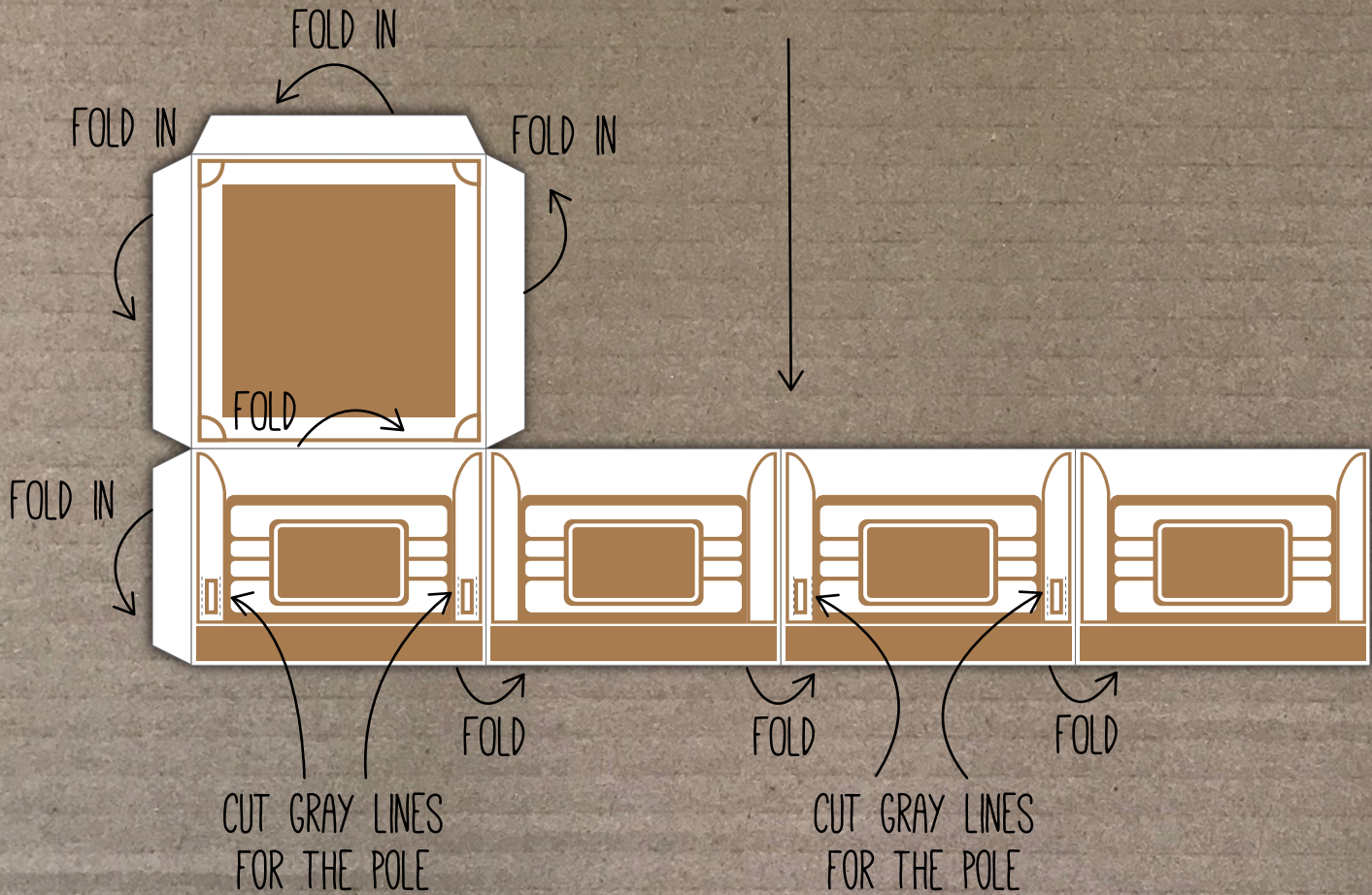

FOLD TO FORM A BOX & GLUE THE FLAPS
ONTO THE EDGES TO FORM A BOX

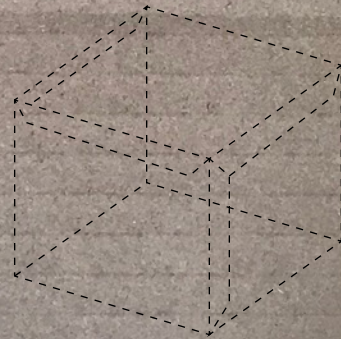

ALTER

1 SHEET OF PURPLE & BROWN CONSTRUCTION PAPER



1 .125IN X
12IN DOWEL

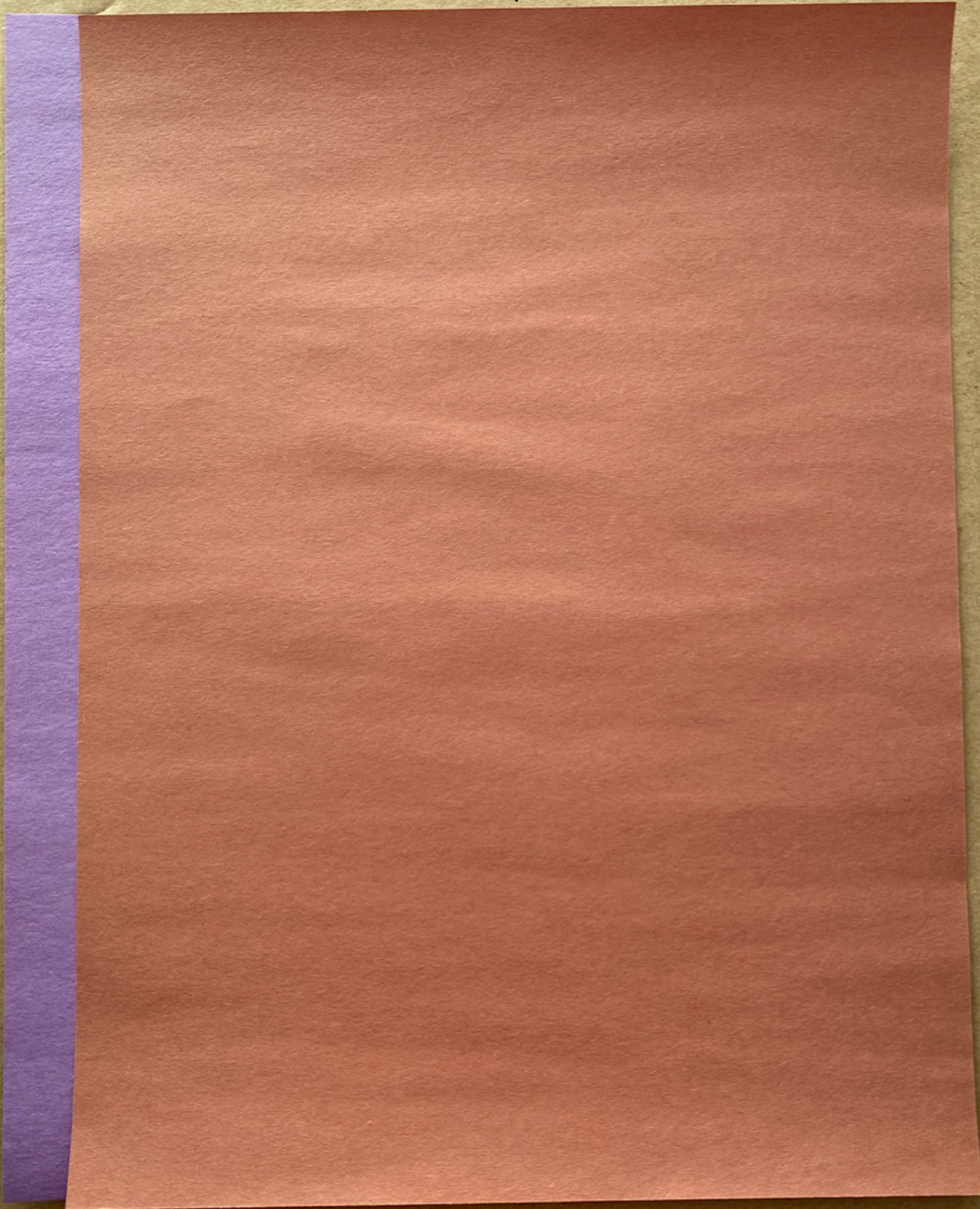
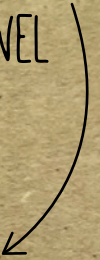

CUT IN
HALF



COLORS BASED OFF OF NUMBERS 4:13-14

ALTER

USE THE BROWN TEMPLATE TO CUT THE BROWN PAPER

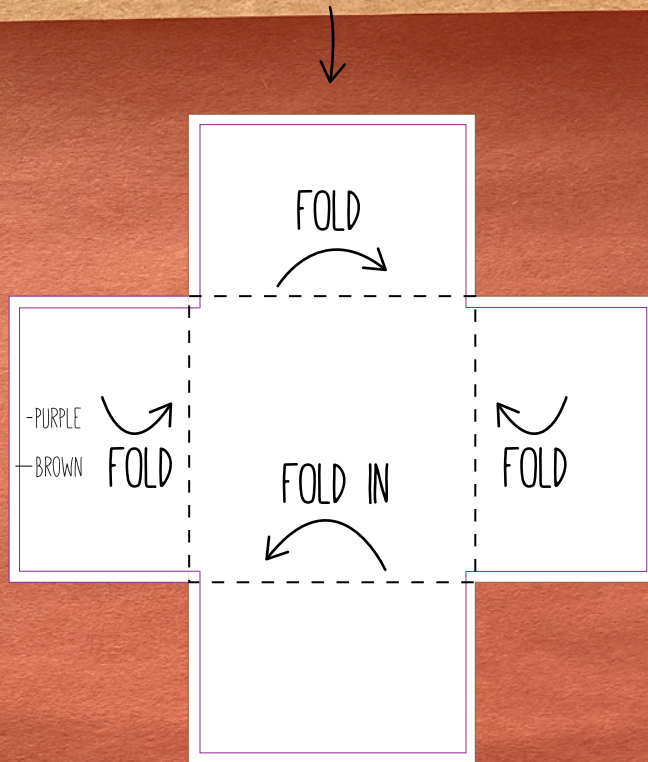

FOLD TO COVER THE BOX

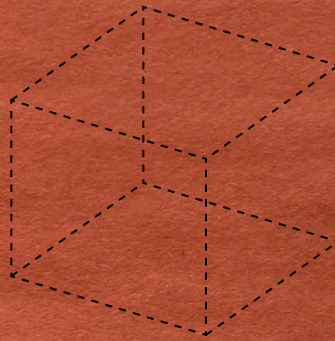

REPEAT CUTTING THE TEMPLATE FOR THE PURPLE PAPER WITH THE PURPLE LINE
FOR ACTIVITY 3 LAYER THE PAPER ON TOP OF INCENSE ALTER: PURPLE THEN BROWN

ALTER

CUT OUT THE BROWN TEMPLATE/PAPER FIRST

PURPLE TEMPLATE/PAPER SECOND

SO THE PAPER CAN LAYER ON TOP OF EACH OTHER

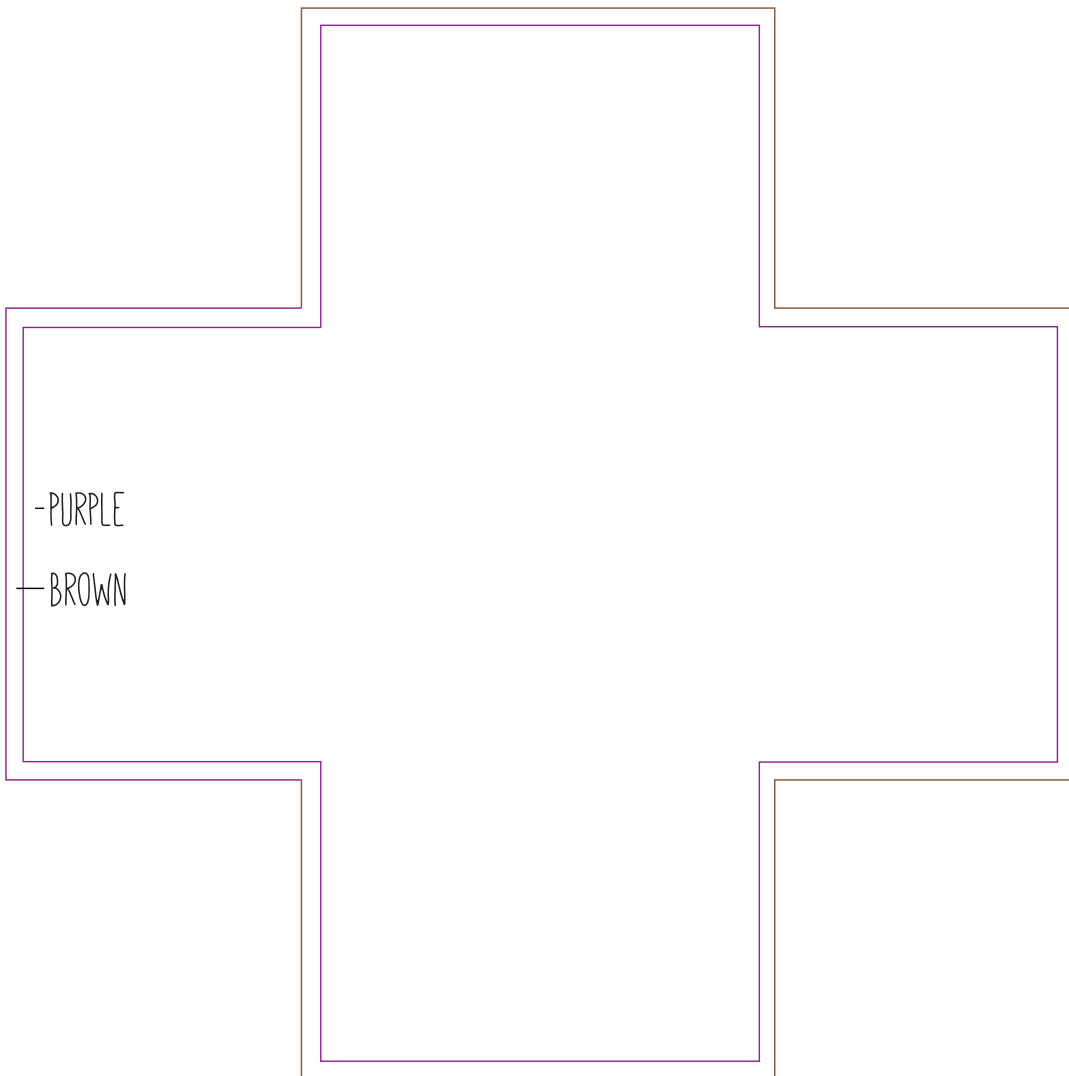

ALTER

INSERT THE .125IN X 6IN
DOWELS INTO THE SLITS

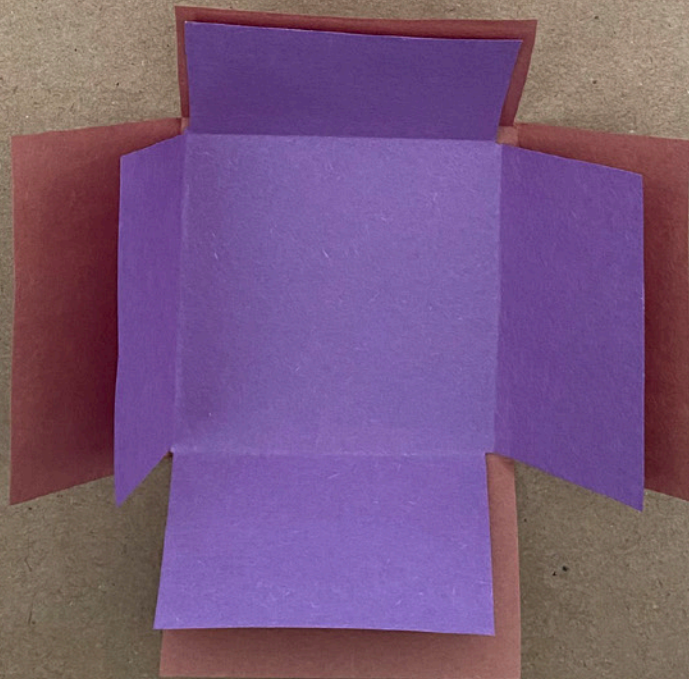
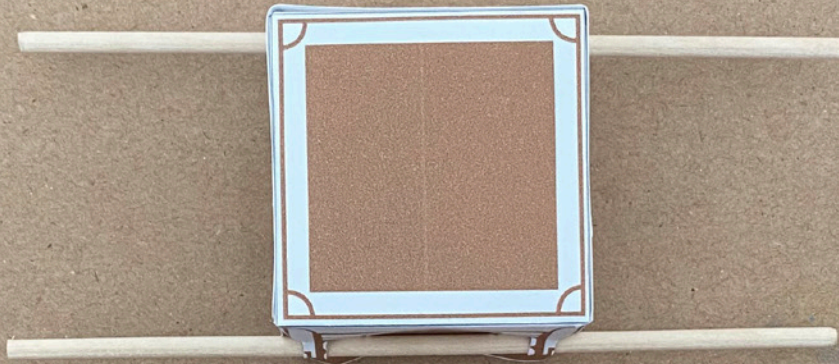

FOLD & LAYER THE PURPLE & BLUE PAPER

ALTER

PLACE THE LAYERED BROWN & PURPLE PAPER ON TOP
OF THE ALTER SO IT IS READY TO MOVE

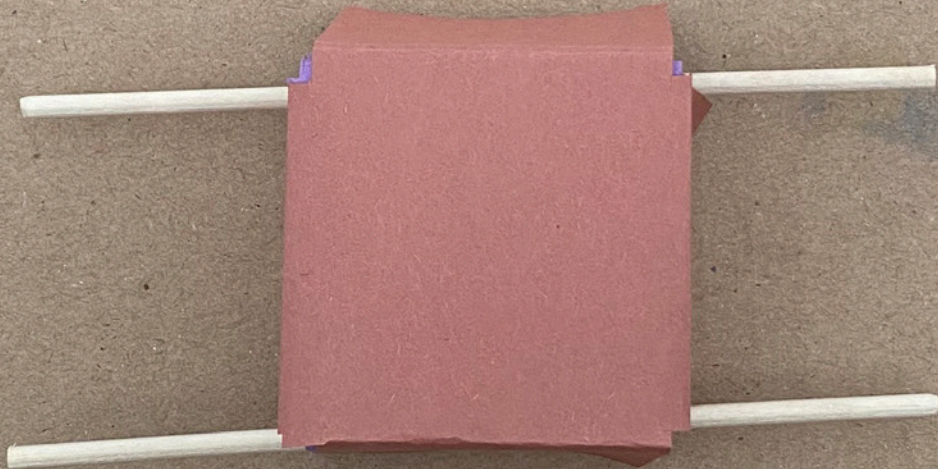

CART

PRINT ON CARD STOCK & CUT OUT
ON THE OUTSIDE LINE

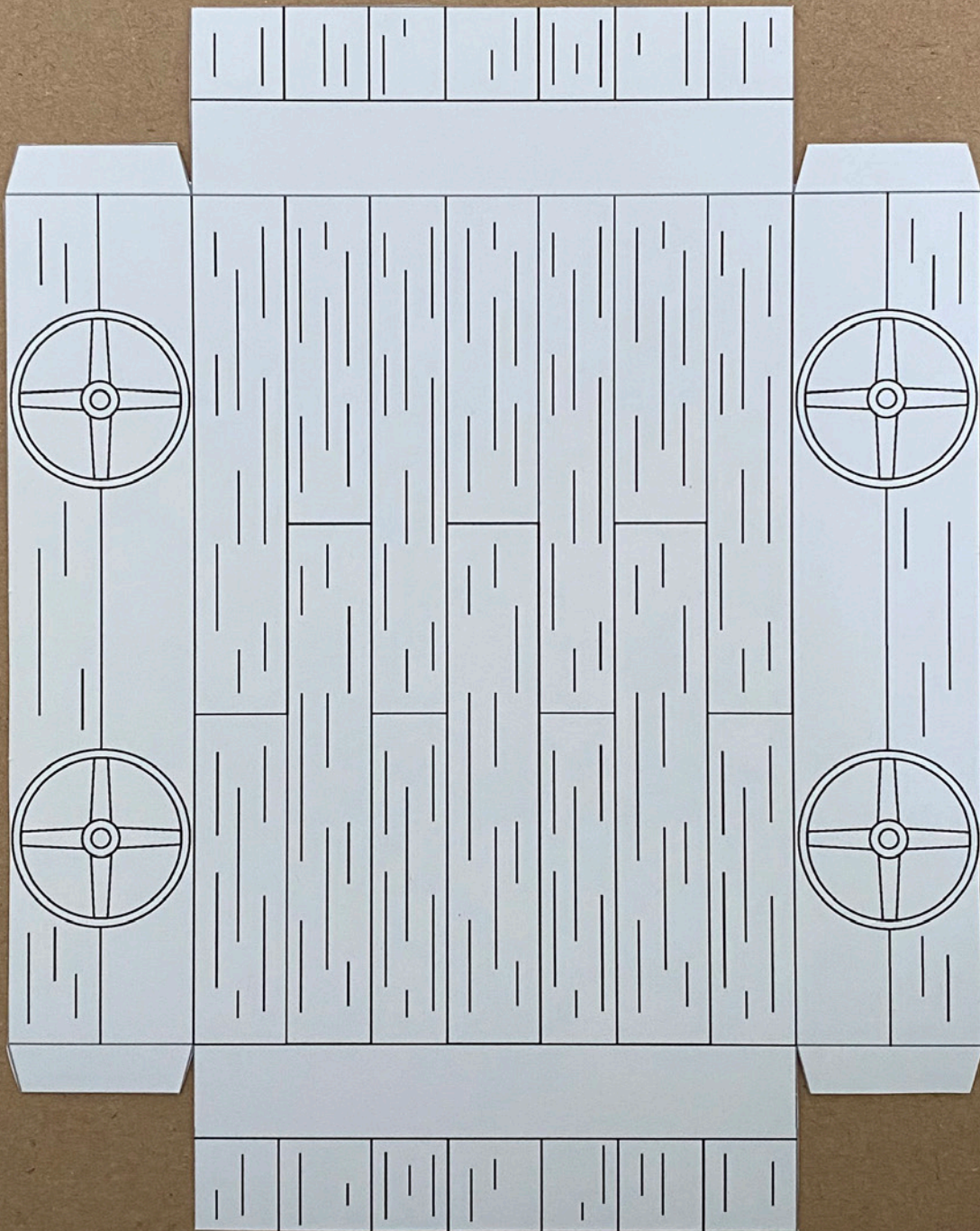

CART

FLIP UPSIDE DOWN, FOLD & GLUE

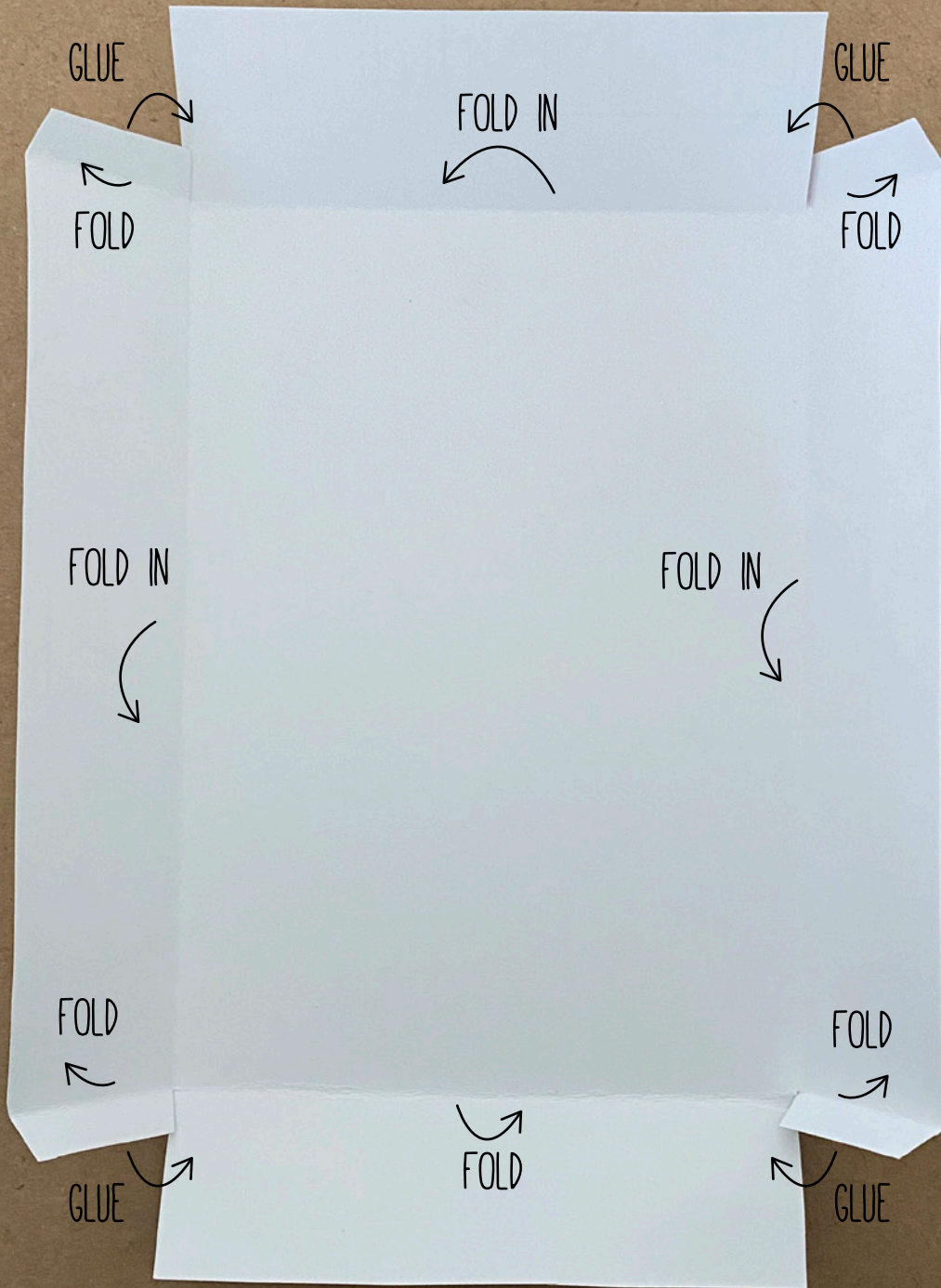

CART

PLACE CURTAINS IN ONE CART & POLES IN THE SECOND CART



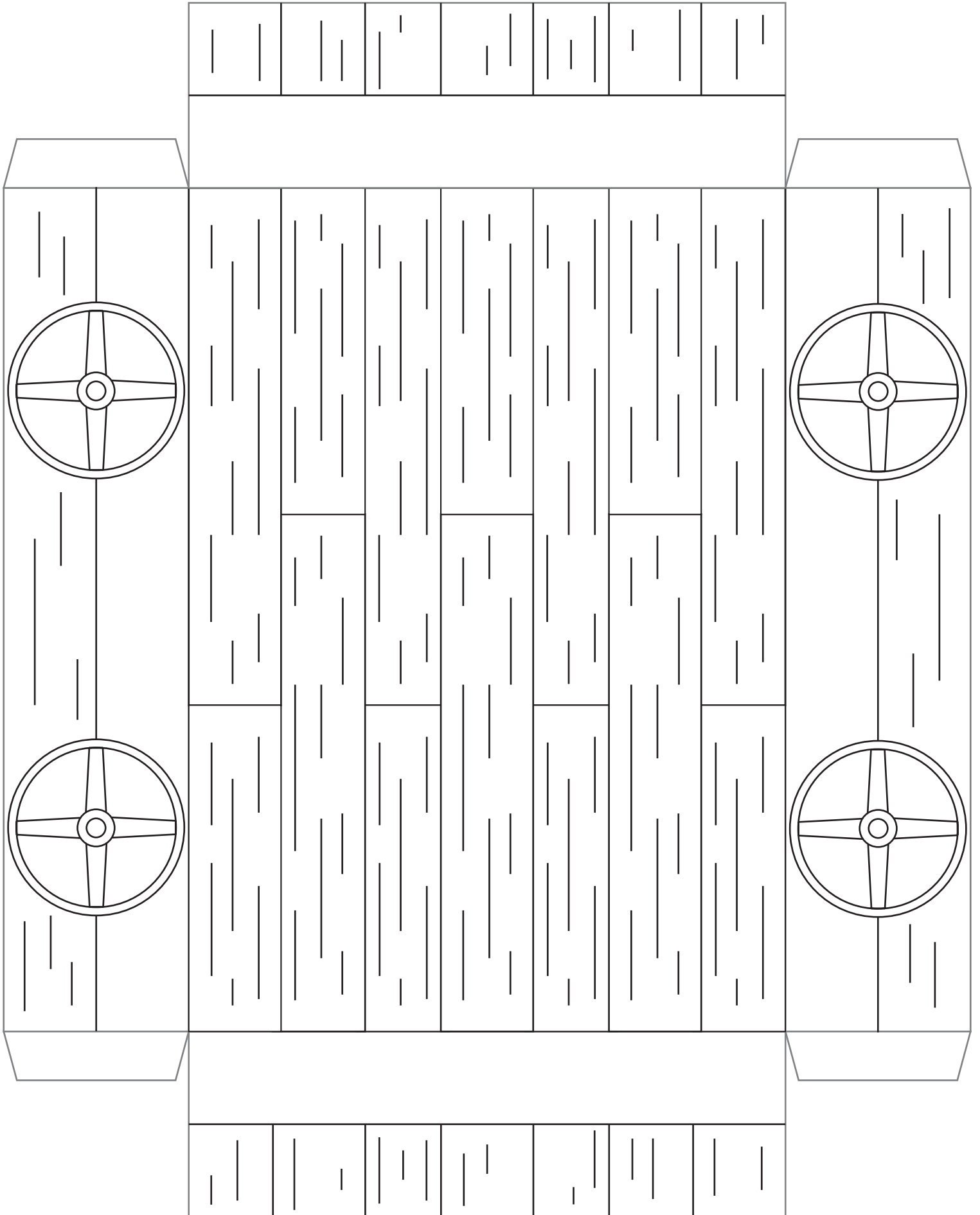

AT THE LORD'S COMMAND THE
ISRAELITES SET OUT, AND AT
HIS COMMAND THEY ENCAMPED.

NUMBERS 9:18

AT THE LORD'S COMMAND THE
ISRAELITES SET OUT, AND AT
HIS COMMAND THEY ENCAMPED.

NUMBERS 9:18

AT THE LORD'S COMMAND THE
ISRAELITES SET OUT, AND AT
HIS COMMAND THEY ENCAMPED.

NUMBERS 9:18

AT THE LORD'S COMMAND THE
ISRAELITES SET OUT, AND AT
HIS COMMAND THEY ENCAMPED.

NUMBERS 9:18