



# JUSTICE WEEK 3



# JUSTICE

## JUSTICE WEEK 3

# VICTORY!

### FOCUS

LUKE 10:18-19 & REVELATION 12:7-10

Michael defeated the dragon,  
and Jesus saw him fall from heaven  
like lightning!

### MATERIALS

Victory picture  
Cardboard clouds from week 1 *optional*  
Michael streamer  
Dragon streamer  
Angel streamers (1 per child)  
Bad angels streamers (1 per adult)  
Dragon paper airplanes (1 per child)  
Small black airplanes (3 per child)  
Feather and coin (1 set per child)  
Victory badge (1 per child)  
Crayons and tape

### ACTIVITIES

#### 1. INTRODUCTION

**TALK:** Ask the children if they know about Michael fighting the dragon!

**ACTIVITY:** Show children the Victory! picture and hang nearby for them to see.



#### 2. WAR IN HEAVEN

**TALK:** War has broken out in heaven! Good angels against bad angels!

**ACTIVITY:** Color the **angel heads** and tape them on the Popsicle stick. Give one child the Michael head to color and place on the paint stick.



### CORRESPONDING VERSE

THEN WAR BROKE OUT  
IN HEAVEN.  
REVELATION 12:7

## ACTIVITIES

### 3. MICHAEL VS THE DRAGON

**TALK:** Michael and his angels fought against the dragon and his angels!

**ACTIVITY:** Give the **bad angels** and dragon to the parents to hold and have the children hold up their angels. Have everyone stand on opposite sides, the good on one side and the bad on the other.

*\*Have everyone stand on a space large enough to run around.*



## CORRESPONDING VERSE

MICHAEL AND HIS ANGELS FOUGHT AGAINST THE DRAGON, AND THE DRAGON AND HIS ANGELS FOUGHT BACK.

REVELATION 12:7

### 4. DEFEATED

**TALK:** The dragon was not strong enough to fight against Michael!

**ACTIVITY:** Have kiddos run around and pull out paper streamers from the dragon and bad angels until they are all gone.

BUT HE WAS NOT STRONG ENOUGH, AND THEY LOST THEIR PLACE IN HEAVEN.

REVELATION 12:8

### 5. VICTORY!

**TALK:** The dragon was hurled down from heaven!

**ACTIVITY:** Make and color the dragon paper airplane.



THE GREAT DRAGON WAS HURLED DOWN—THAT ANCIENT SERPENT CALLED THE DEVIL, OR SATAN, WHO LEADS THE WORLD ASTRAY.

REVELATION 12:8

### 6. HURLED DOWN

**TALK:** The dragon was hurled to earth, and so were his angels!

**ACTIVITY:** Throw the dragon paper airplane down and give them small black airplanes to throw down as well.



HE WAS HURLED TO THE EARTH, AND HIS ANGELS WITH HIM.

REVELATION 12:9

### 7. VOICE FROM HEAVEN

**TALK:** After the angels were hurled down, another Angel said, “Now have come the salvation and the power and the kingdom of our God, and the authority of his Messiah.”

**ACTIVITY:** Call out “Now have come the salvation and the power and the kingdom of our God, and the authority of his Messiah.” in a loud voice.

THEN I HEARD A LOUD VOICE IN HEAVEN SAY: NOW HAVE COME THE SALVATION AND THE POWER AND THE KINGDOM OF OUR GOD, AND THE AUTHORITY OF HIS MESSIAH.

REVELATION 12:10

## ACTIVITIES

### 8. JESUS SAW IT

**TALK:** Jesus told his disciples that he saw Satan fall like lightning from heaven!

**ACTIVITY:** Throw a feather down to represent slow and coin for fast!

### 9. VICTORY FOR US!

**TALK:** After Jesus saw Satan fall, he said to his disciples that he had given them power to overcome the enemy!

**ACTIVITY:** Give each child a badge that says I have authority to overcome the enemy!

**OPTIONAL:** Hand out each child a bible verse to take home.



## CORRESPONDING VERSE

HE REPLIED, "I SAW SATAN FALL LIKE LIGHTNING FROM HEAVEN."

LUKE 10:18

I HAVE GIVEN YOU AUTHORITY TO TRAMPLE ON SNAKES AND SCORPIONS AND TO OVERCOME ALL THE POWER OF THE ENEMY; NOTHING WILL HARM YOU.

LUKE 10:19

HE REPLIED,  
"I SAW SATAN FALL LIKE  
LIGHTNING FROM HEAVEN."

LUKE 10:18

VICTORY!

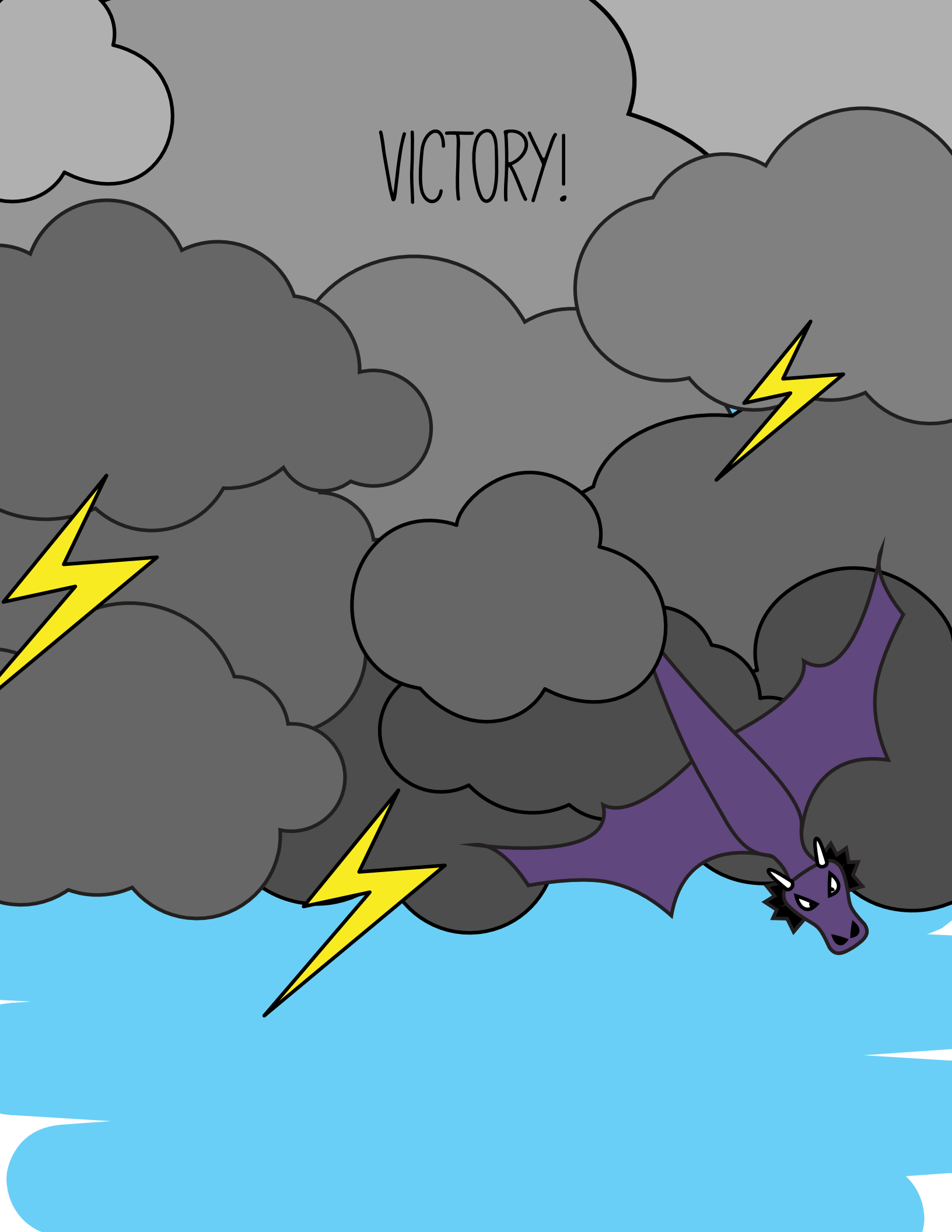

# HEAVEN

I reused the cardboard clouds from week 1 and set them up around the space we were going to “fight” in to make it look like we were in heaven!



# MICHAEL

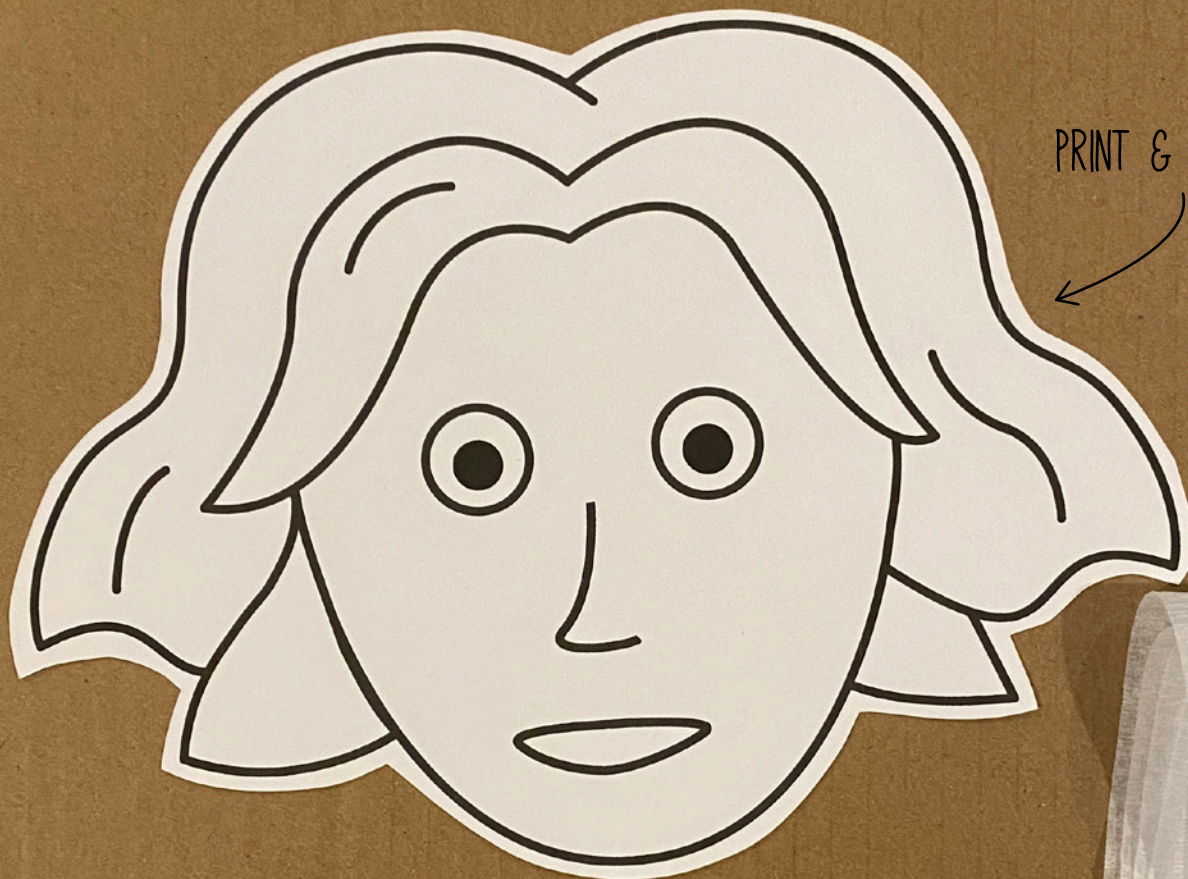

PRINT & CUT OUT



1 QUART PAINT STICK

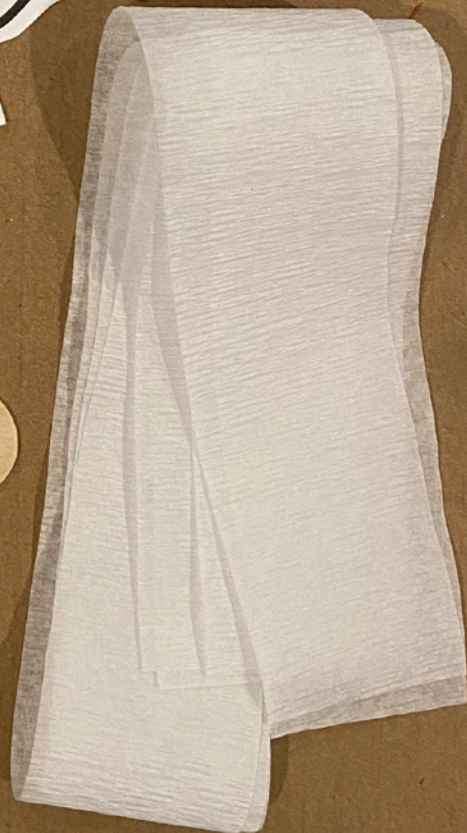

3 24" WHITE  
STREAMERS



# MICHAEL

TAPE THE STREAMERS TO THE TOP  
OF THE QUART PAINT STICK

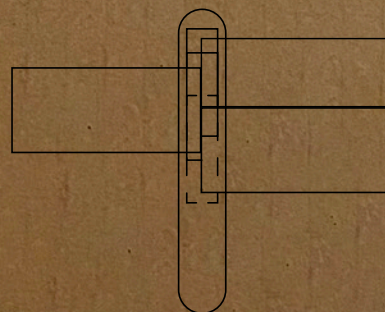
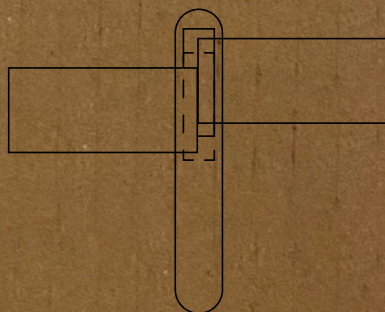
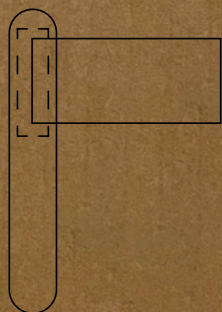
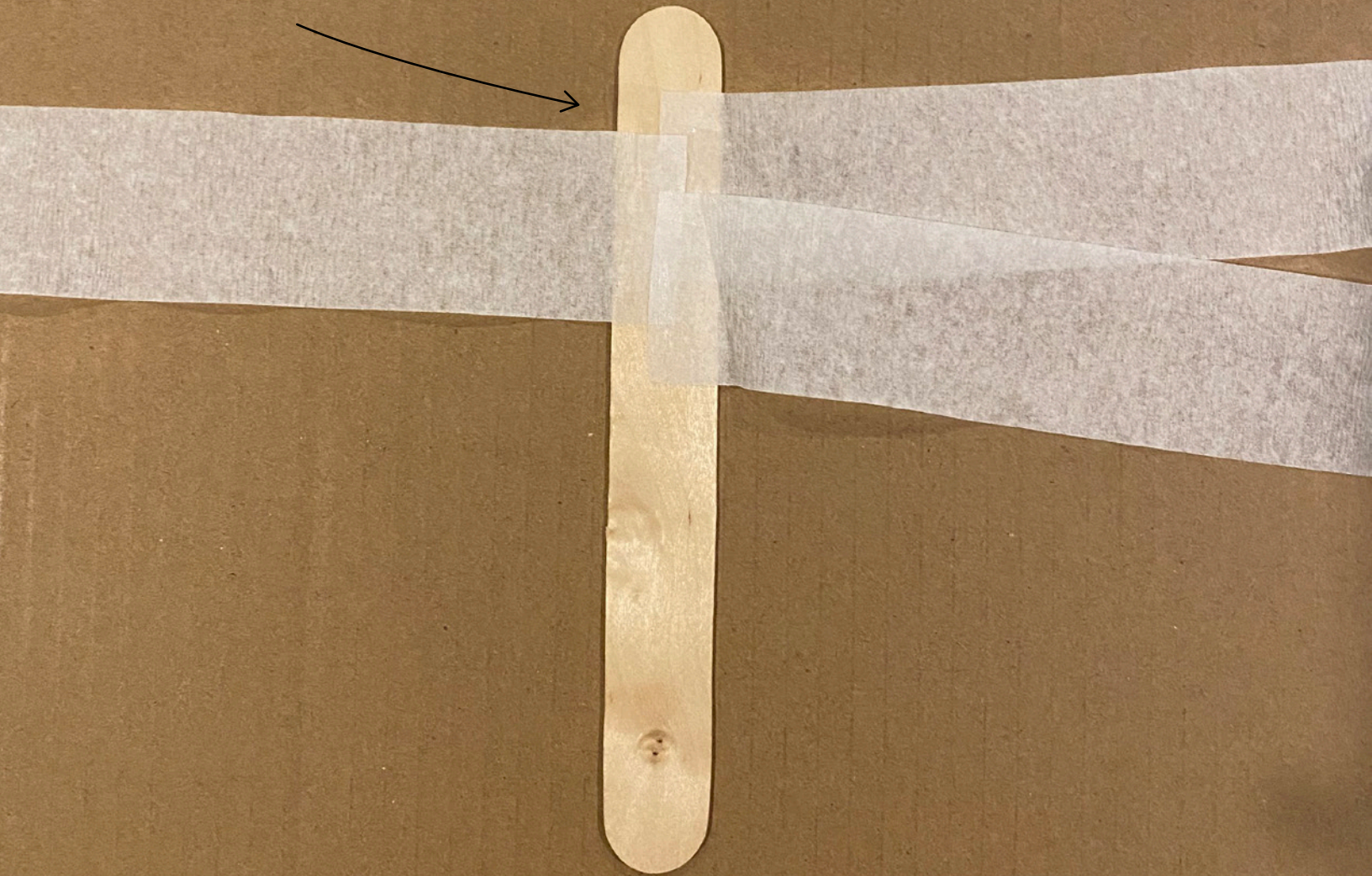



# MICHAEL

TAPE HEAD TO THE FRONT  
OF THE PAINT STICK

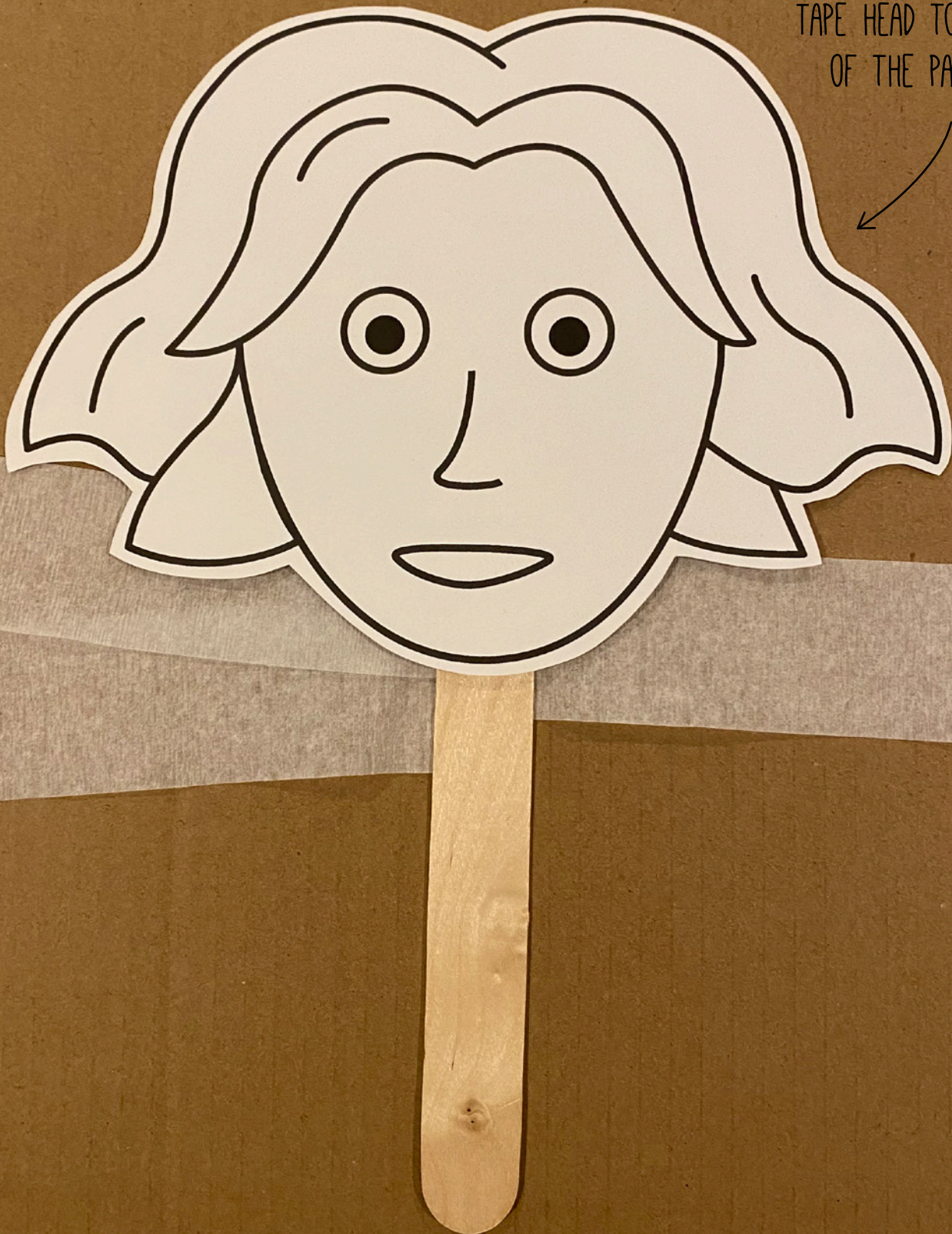

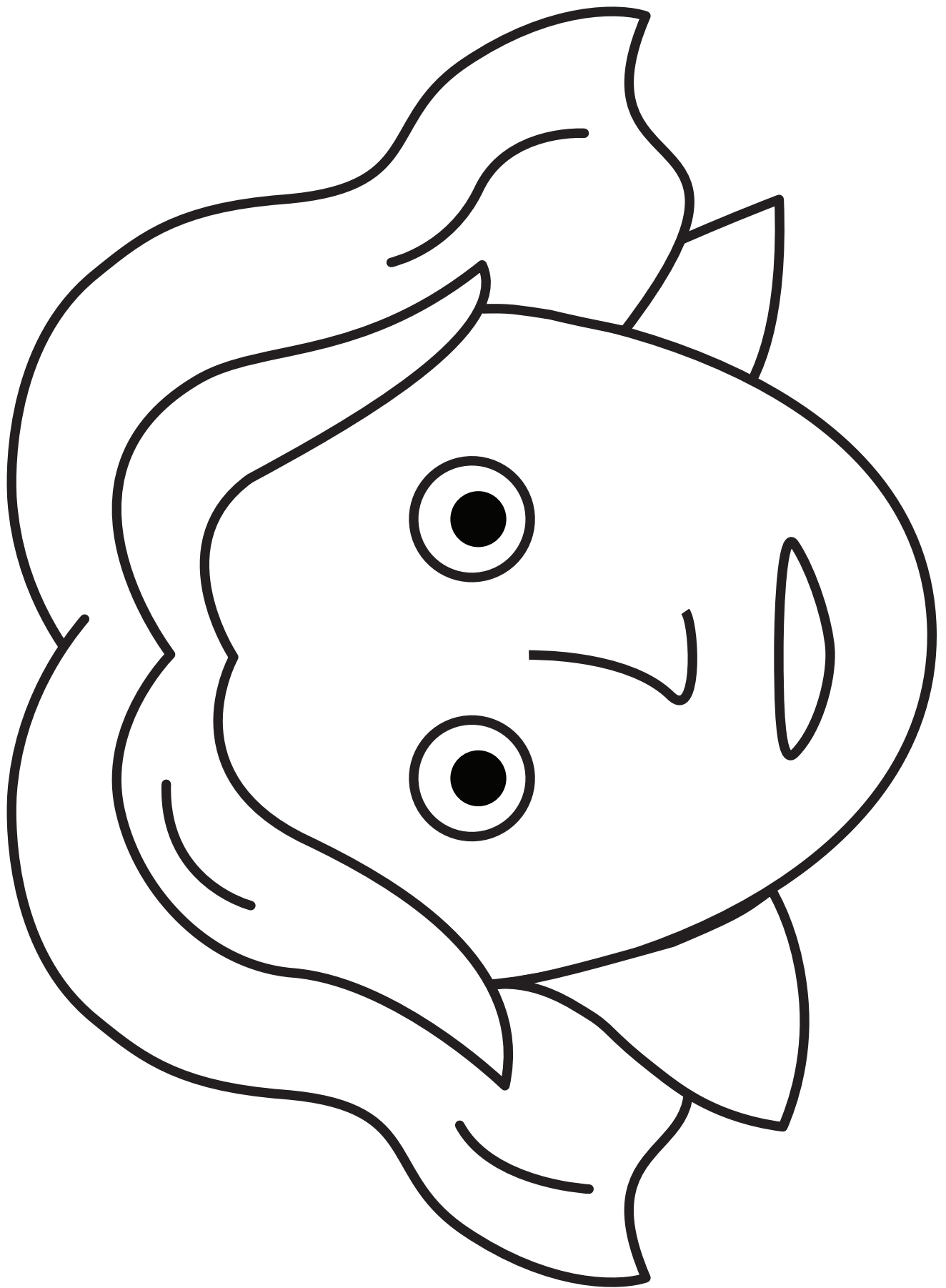

# ANGELS

PRINT & CUT OUT



1 JUMBO  
POPSICLE STICK

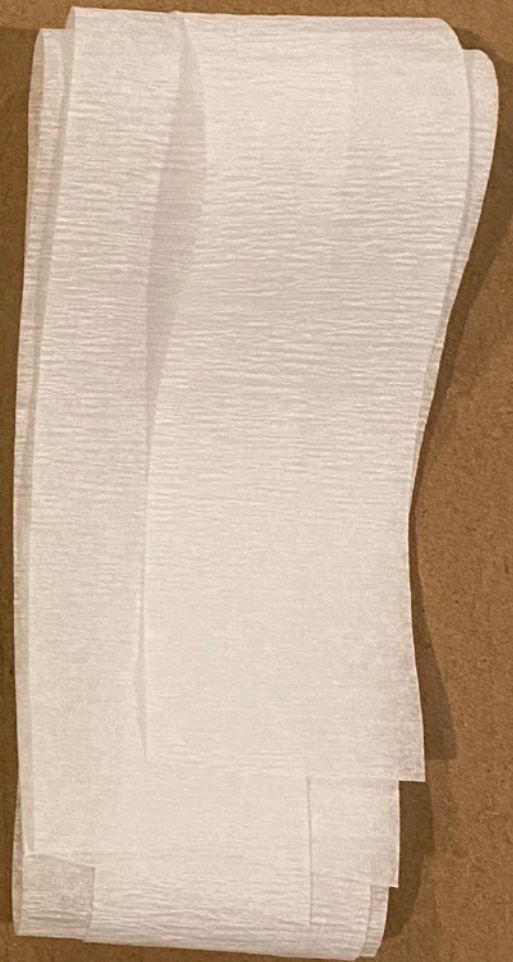

3 24" WHITE  
STREAMERS

# ANGELS

TAPE THE STREAMERS TO THE TOP  
OF THE JUMBO POPSICLE STICK

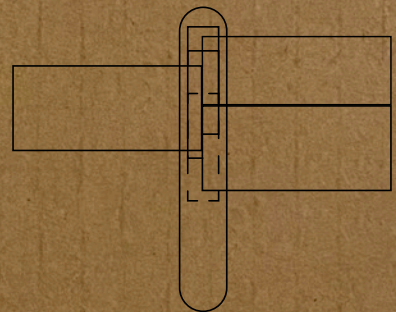
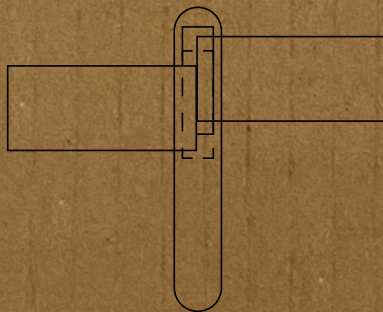
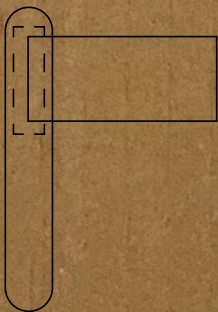
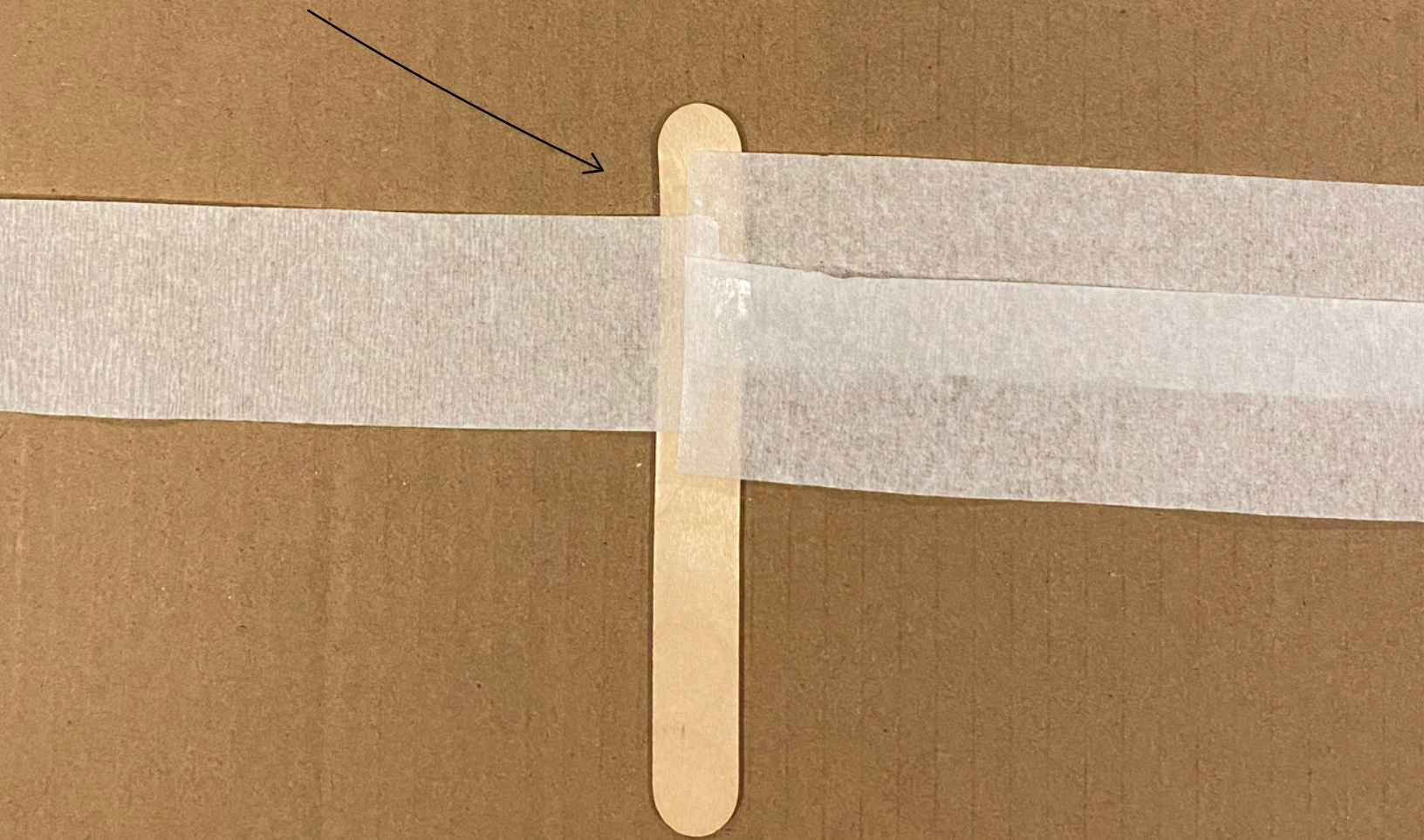

# ANGELS

TAPE HEAD TO THE FRONT  
OF THE POPSICLE STICK



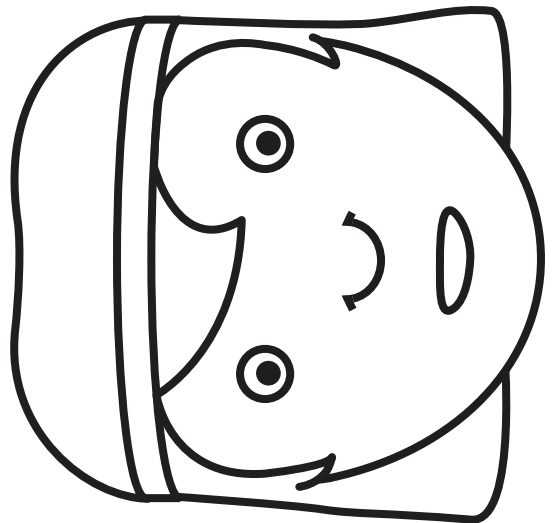
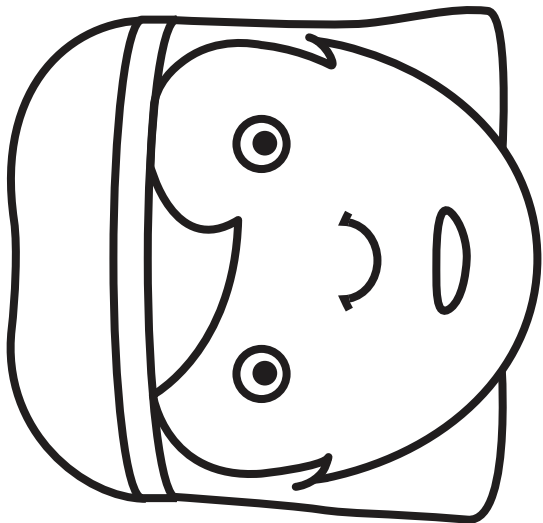
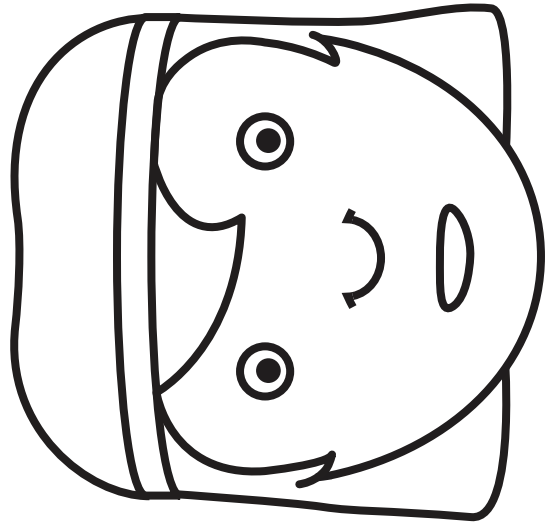
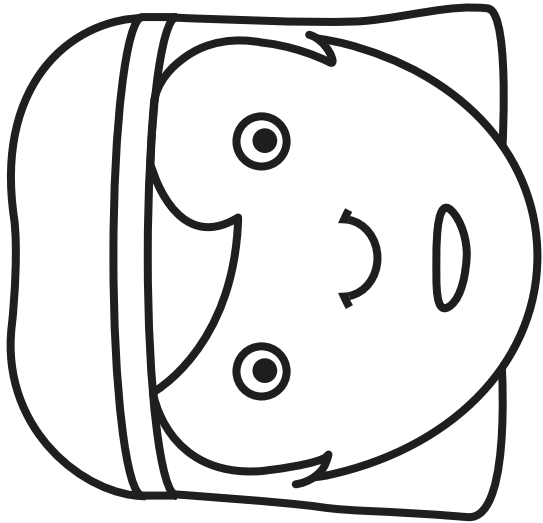
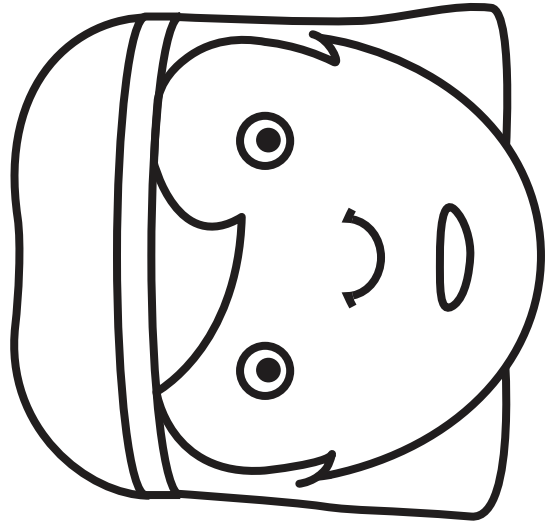
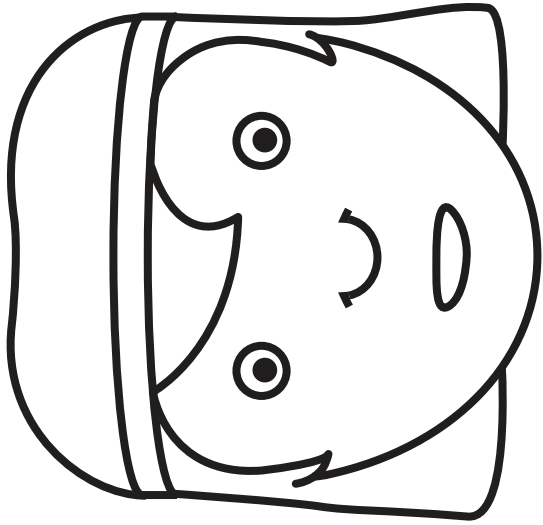

# DRAGON

PRINT & CUT OUT



3 24" BLACK  
STREAMERS



1 QUART PAINT STICK

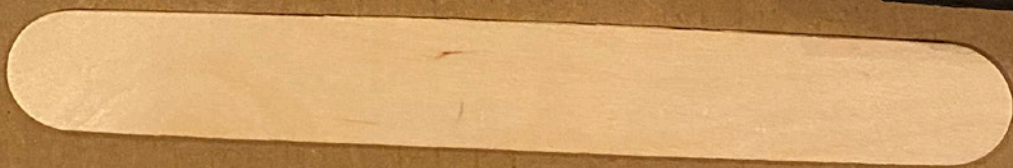

# DRAGON

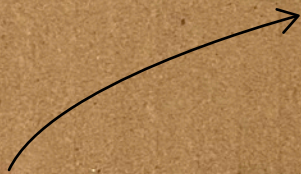

TAPE THE STREAMERS TO THE TOP  
OF THE QUART PAINT STICK

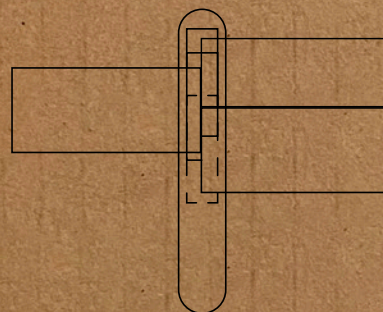
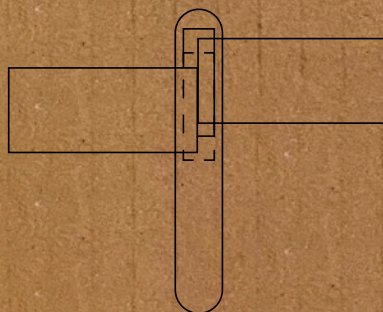
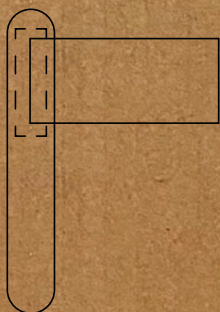



# DRAGON

TAPE HEAD TO THE FRONT  
OF THE PAINT STICK



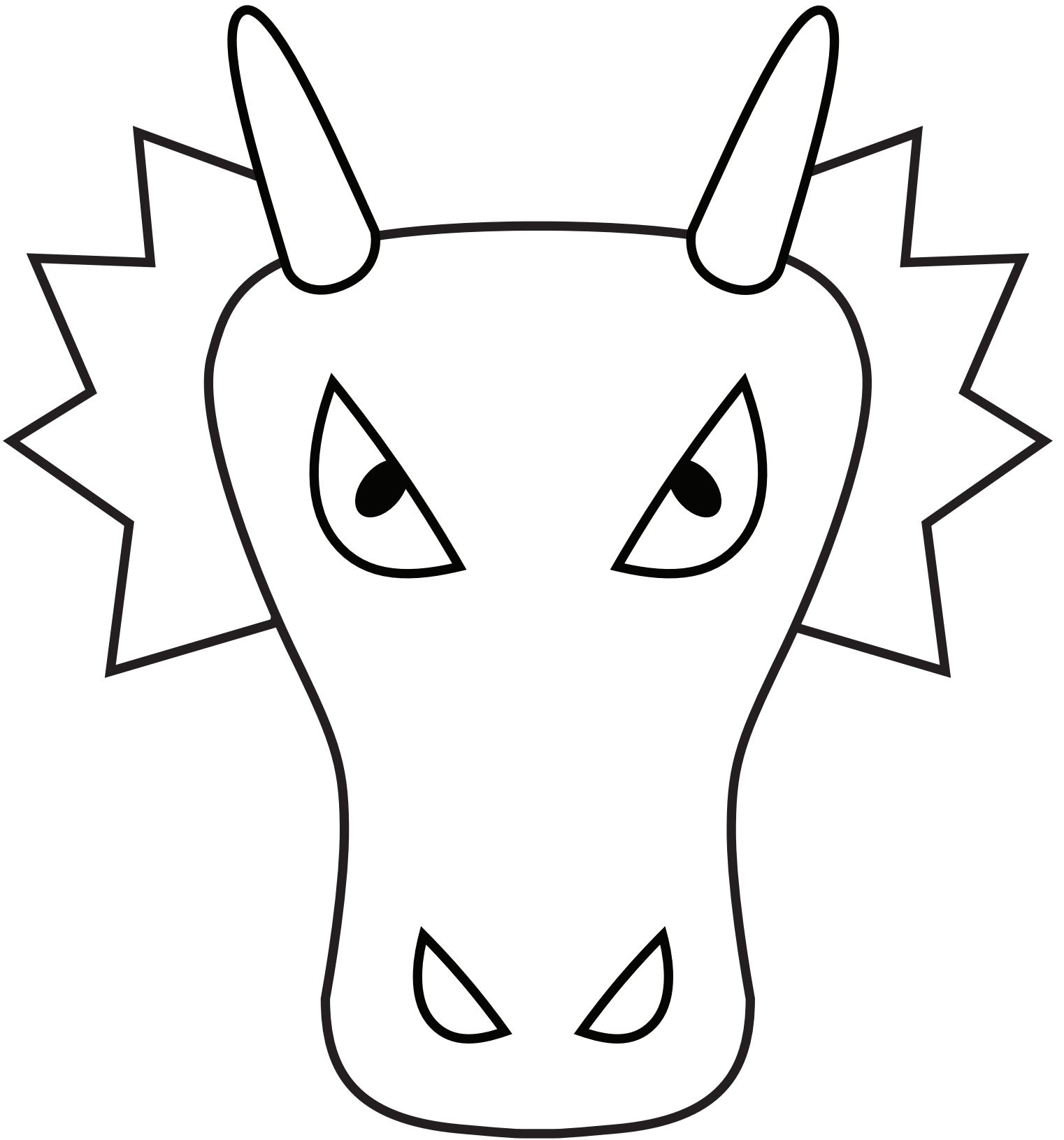

# BAD ANGELS

PRINT & CUT OUT

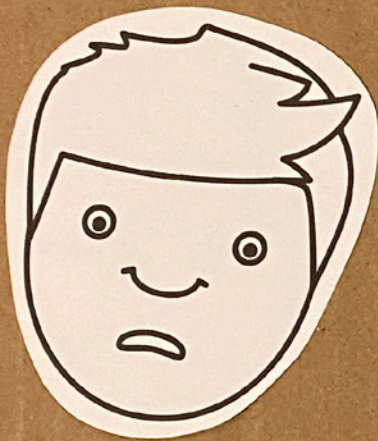
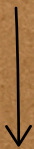

1 JUMBO  
POPSICLE STICK

3 24" BLACK  
STREAMERS

# BAD ANGELS

TAPE THE STREAMERS TO THE TOP  
OF THE JUMBO POPSICLE STICK

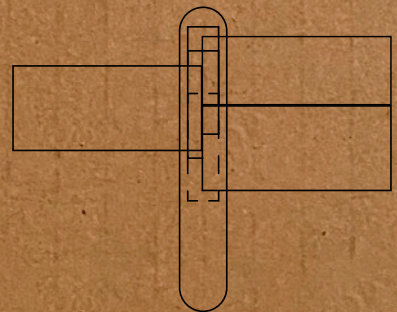
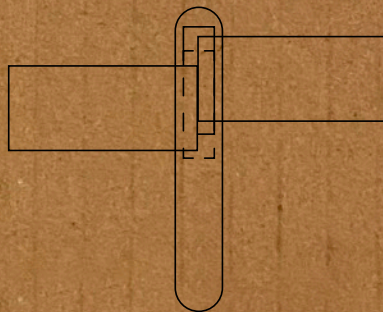
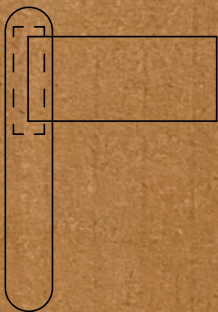
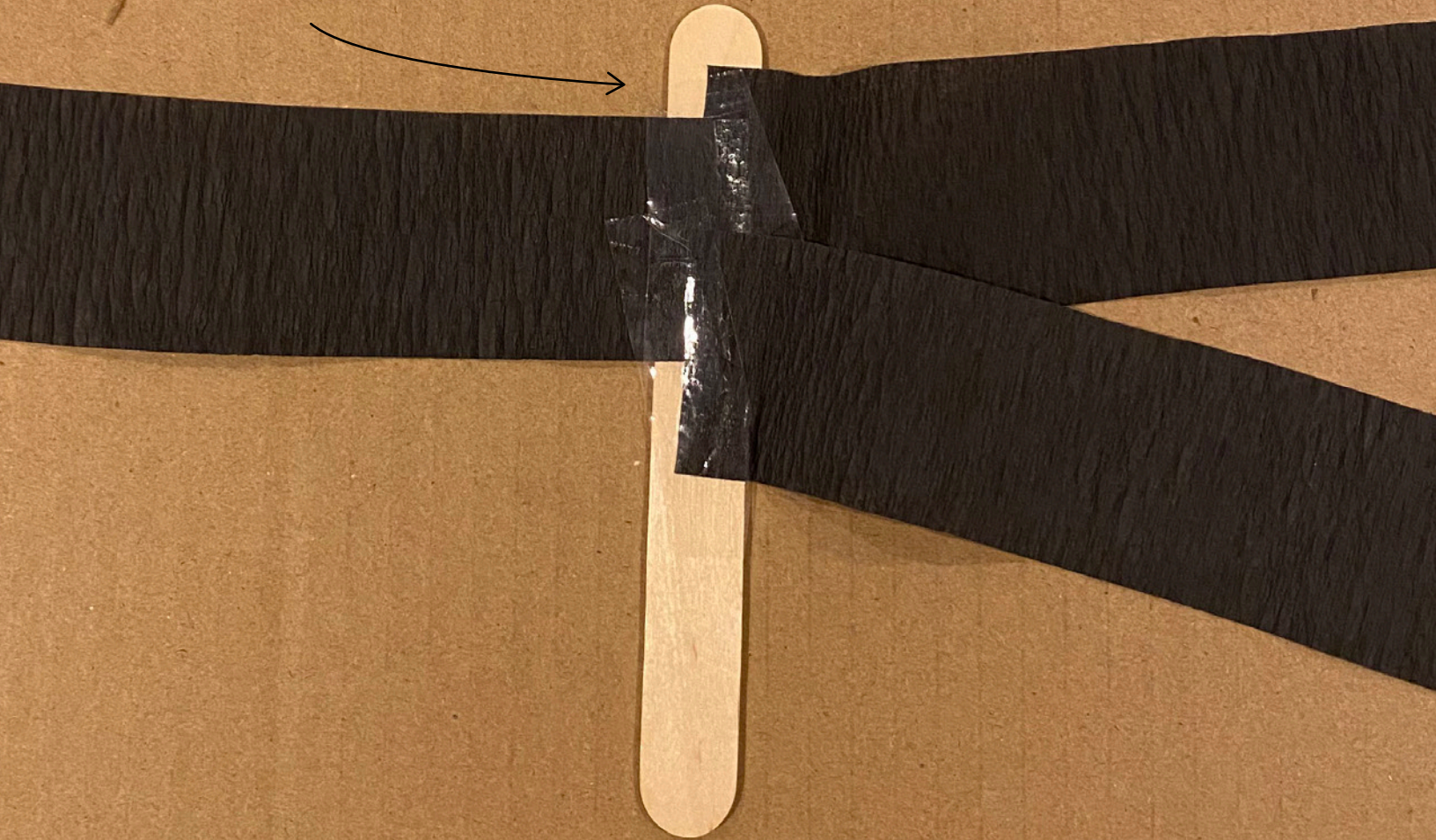

# BAD ANGELS

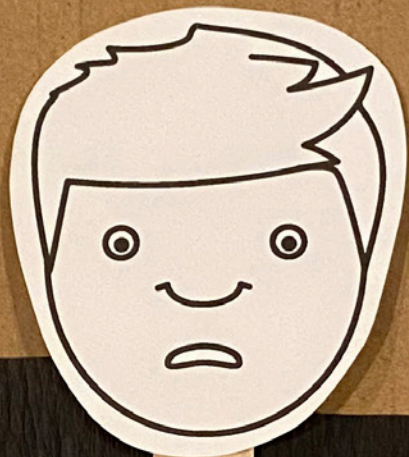

TAPE HEAD TO THE FRONT  
OF THE POPSICLE STICK



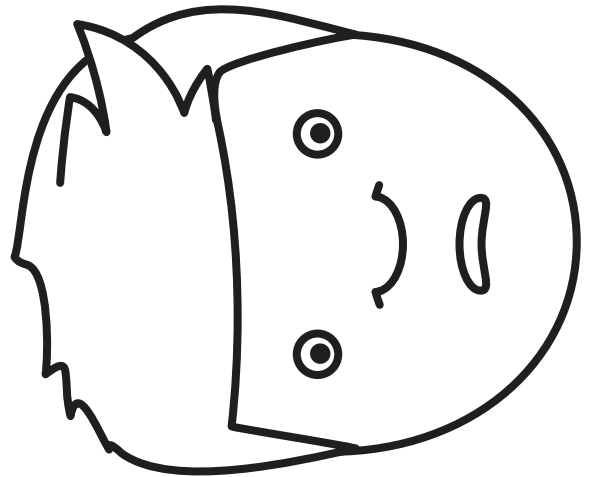
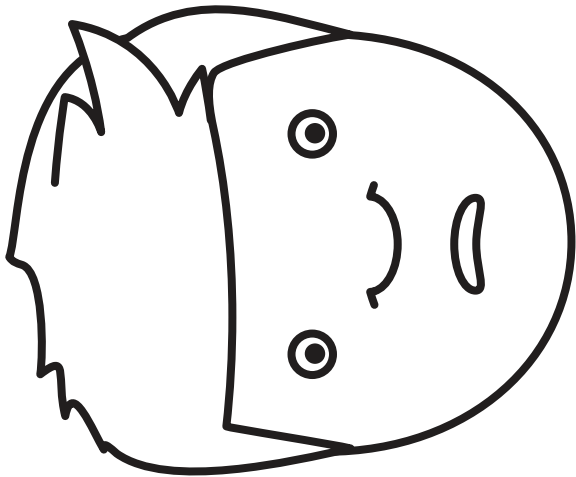
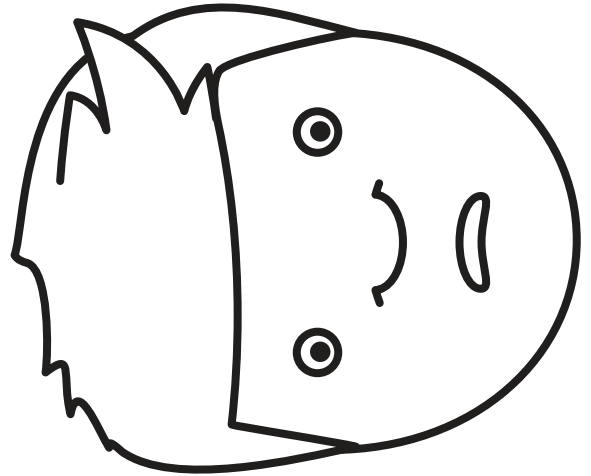
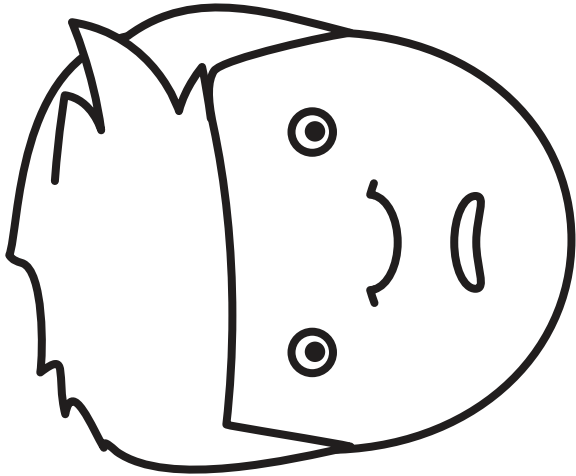
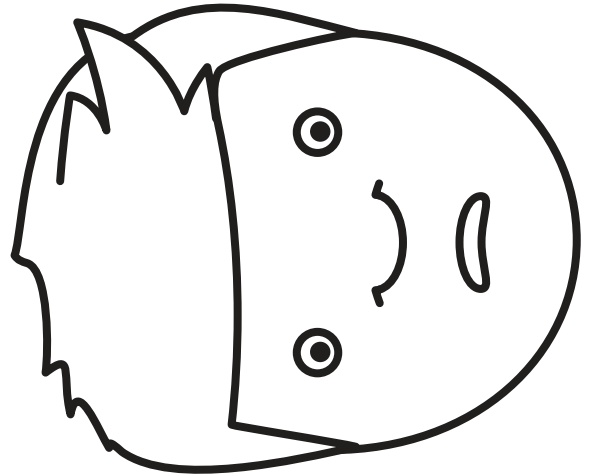
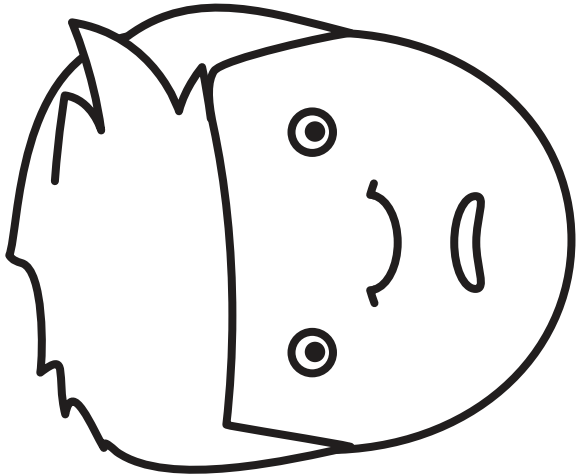

# DRAGON PAPER AIRPLANE

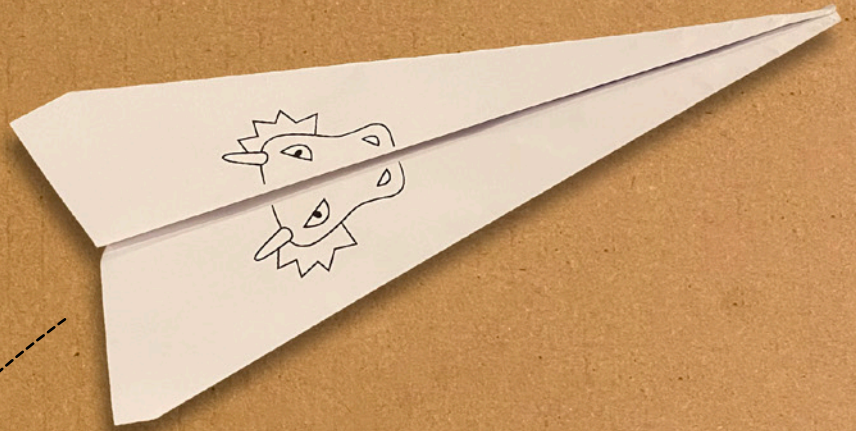

PRINT THEN FLIP UPSIDE DOWN  
& BACKWARDS TO START

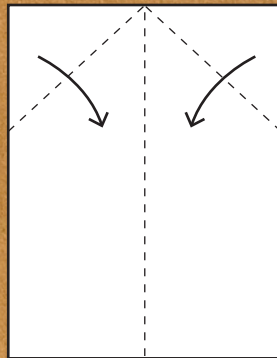
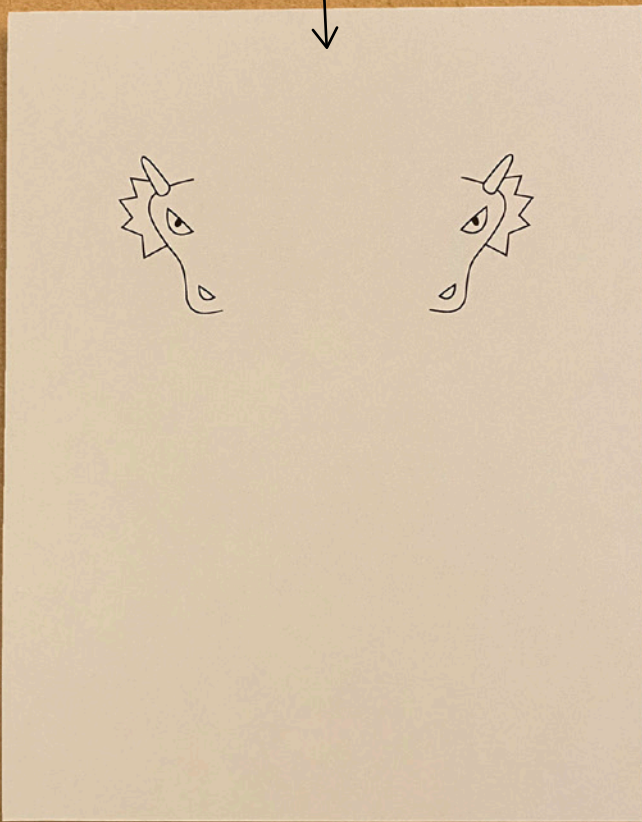

FOLD & UNFOLD  
CREASES AS SHOWN

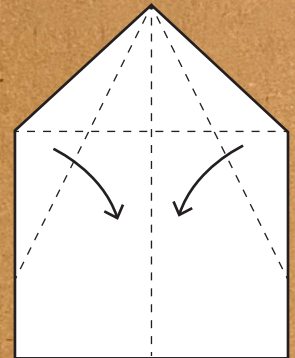

FOLD & UNFOLD  
CREASES AS SHOWN

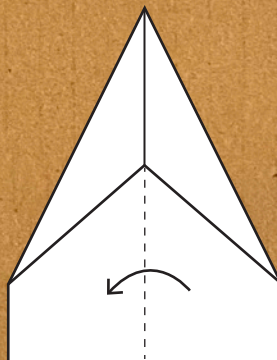

FOLD IN HALF  
HORIZONTALLY

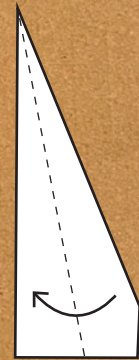

FOLD DOWN TO  
FORM WING



REPEAT BOTH SIDES

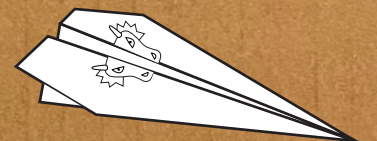





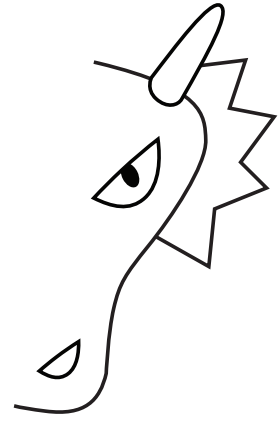
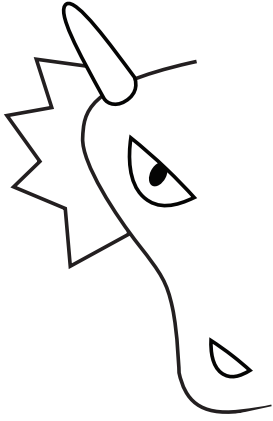

# BLACK PAPER AIRPLANE

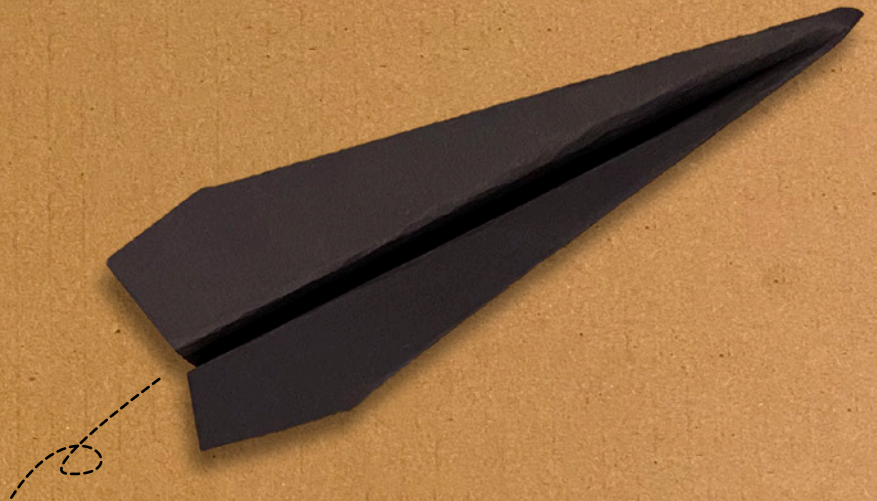

4.5"x6" BLACK CONSTRUCTION PAPER

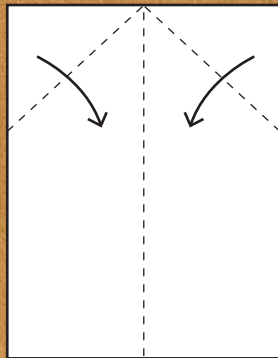
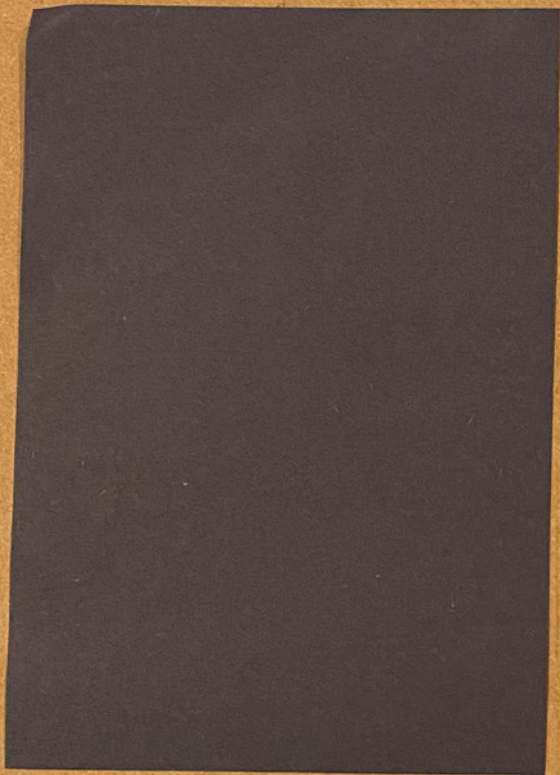

FOLD & UNFOLD  
CREASES AS SHOWN

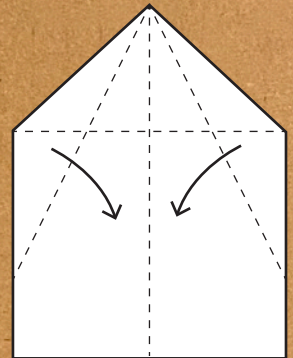

FOLD & UNFOLD  
CREASES AS SHOWN

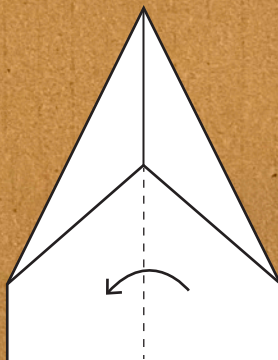

FOLD IN HALF  
HORIZONTALLY

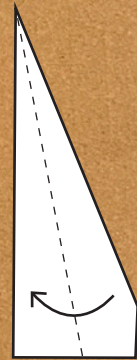

FOLD DOWN TO  
FORM WING



REPEAT BOTH SIDES

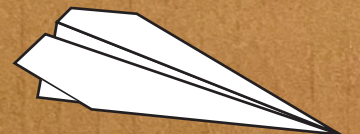

NOW HAVE COME THE  
SALVATION AND THE POWER  
AND THE KINGDOM OF OUR  
GOD, AND THE AUTHORITY  
OF HIS MESSIAH.



HE REPLIED,  
"I SAW SATAN FALL LIKE  
LIGHTNING FROM HEAVEN."

LUKE 10:18

HE REPLIED,  
"I SAW SATAN FALL LIKE  
LIGHTNING FROM HEAVEN."

LUKE 10:18

HE REPLIED,  
"I SAW SATAN FALL LIKE  
LIGHTNING FROM HEAVEN."

LUKE 10:18

HE REPLIED,  
"I SAW SATAN FALL LIKE  
LIGHTNING FROM HEAVEN."

LUKE 10:18