

# MOUNTAINS

## MOUNTAINS

## THE TRANSFIGURATION

---

### FOCUS

MATTHEW 17:2, LUKE 6:12, 9:28, 30 & 33-35

Jesus loved to pray on mountains! He took 3 of his disciples up a mountain to pray with him, and they got to see Jesus in His glory! Then they got to see Moses, Elijah and hear the voice of God from a cloud!

### MATERIALS

Jesus, Peter, James, John, Moses & Elijah puppet (1 set per child)

Mountain scene (1 per child)

Flashlight (1 per child)

3 tents (1 set per child)

Large blanket or sheet

Crayons and tape

### ACTIVITIES

#### 1. GOING TO PRAY

**TALK:** Jesus liked to go on mountains alone to pray to God! Sometimes he would spend the night there praying!

**ACTIVITY:** Color and make the **Jesus puppet** and act out Jesus climbing the mountain to pray!



### CORRESPONDING VERSE

ONE OF THOSE DAYS JESUS WENT OUT TO A MOUNTAIN SIDE TO PRAY, AND SPENT THE NIGHT PRAYING TO GOD.

LUKE 6:12

#### 2. PRAYING TOGETHER

**TALK:** One day Jesus took Peter, James and John with him up a mountain to pray!

**ACTIVITY:** Color and make the three disciples puppets and act out the scene!



HE TOOK PETER, JOHN AND JAMES WITH HIM AND WENT UP ONTO A MOUNTAIN TO PRAY.

LUKE 9:28

## ACTIVITIES

### 3. JESUS CHANGED!

**TALK:** While Jesus was praying, he changed! He became bright! Like he was shining!

**ACTIVITY:** Place a flashlight behind Jesus to make Him shine

### 4. MOSES & ELIJAH

**TALK:** After Jesus changed, Moses and Elijah were there too; and they were shining!

**ACTIVITY:** Color and make the Moses and Elijah puppets and shine the light behind them.

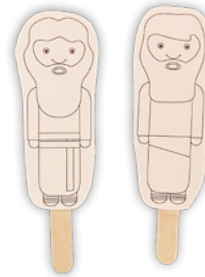

### 5. MAKE TENTS

**TALK:** Peter woke up and saw Jesus and two men with him! They were all shining! So Peter asked Jesus if he could make tents for them!

**ACTIVITY:** Color and fold the three tents.



### 6. VOICE FROM HEAVEN

**TALK:** While Peter was talking to Jesus, a cloud came down and God spoke to them! He told the disciples that Jesus was His son and to listen to him!

**ACTIVITY:** Place a large sheet over you and your Tiny Arrow and say “This is my Son, whom I have chosen; listen to him.”

**OPTIONAL:** Hand out each child a bible verse to take home.

HE TOOK PETER, JOHN AND  
JAMES WITH HIM AND WENT UP  
ONTO A MOUNTAIN TO PRAY.

LUKE 9:28

## CORRESPONDING VERSE

THERE HE WAS TRANSFIGURED BEFORE THEM. HIS FACE SHONE LIKE THE SUN, AND HIS CLOTHES BECAME AS WHITE AS THE LIGHT.

MATTHEW 17:2

TWO MEN, MOSES AND ELIJAH, APPEARED IN GLORIOUS SPLendor, TALKING WITH JESUS.

LUKE 9:30

AS THE MEN WERE LEAVING JESUS, PETER SAID TO HIM, “MASTER, IT IS GOOD FOR US TO BE HERE. LET US PUT UP THREE SHELTERS—ONE FOR YOU, ONE FOR MOSES AND ONE FOR ELIJAH.” (HE DID NOT KNOW WHAT HE WAS SAYING.)

LUKE 9:33

WHILE HE WAS SPEAKING, A CLOUD APPEARED AND COVERED THEM, AND THEY WERE AFRAID AS THEY ENTERED THE CLOUD. A VOICE CAME FROM THE CLOUD, SAYING, “THIS IS MY SON, WHOM I HAVE CHOSEN; LISTEN TO HIM.”

LUKE 9:34-35

# MOUNTAIN

18" X 12" CARDBOARD

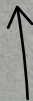
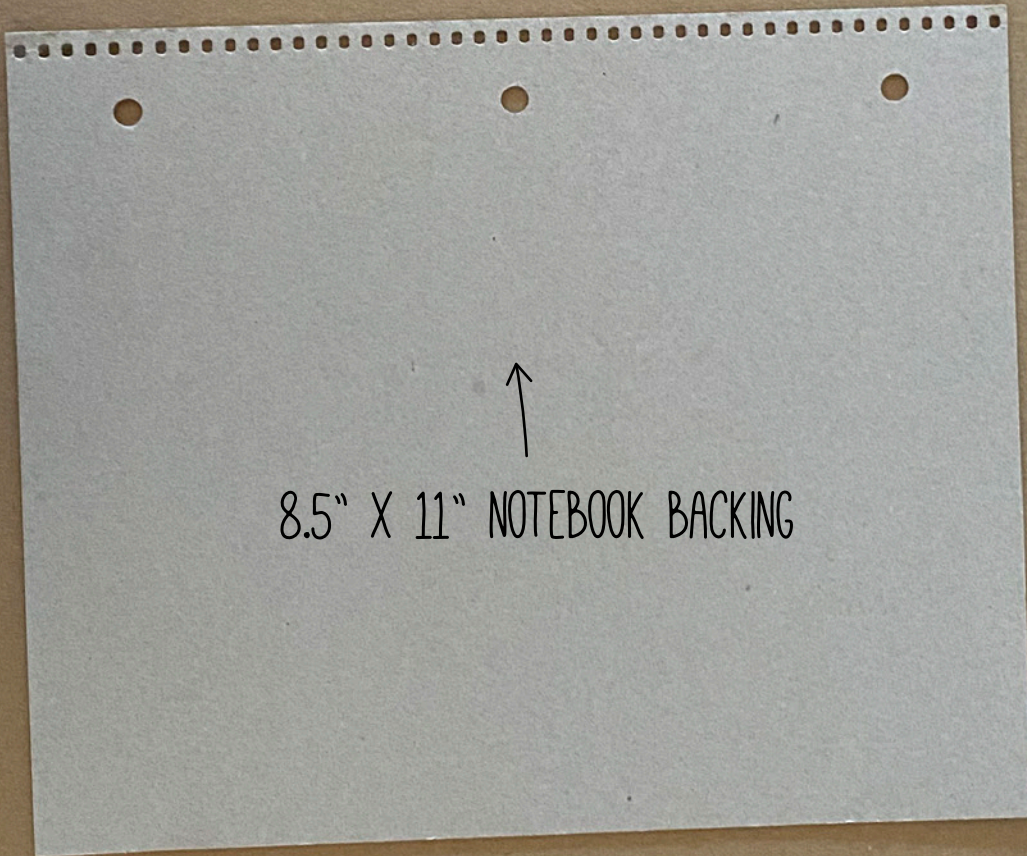

8.5" X 11" NOTEBOOK BACKING

# MOUNTAIN

CUT OUT IN A MOUNTAIN  
LIKE SHAPE

SHORTEN THE BACKING  
SO IT IS NOT TALLER  
THAN THE MOUNTAIN

TAPE THE BACKING TO  
THE BACK SO IT CAN  
FREELY STAND

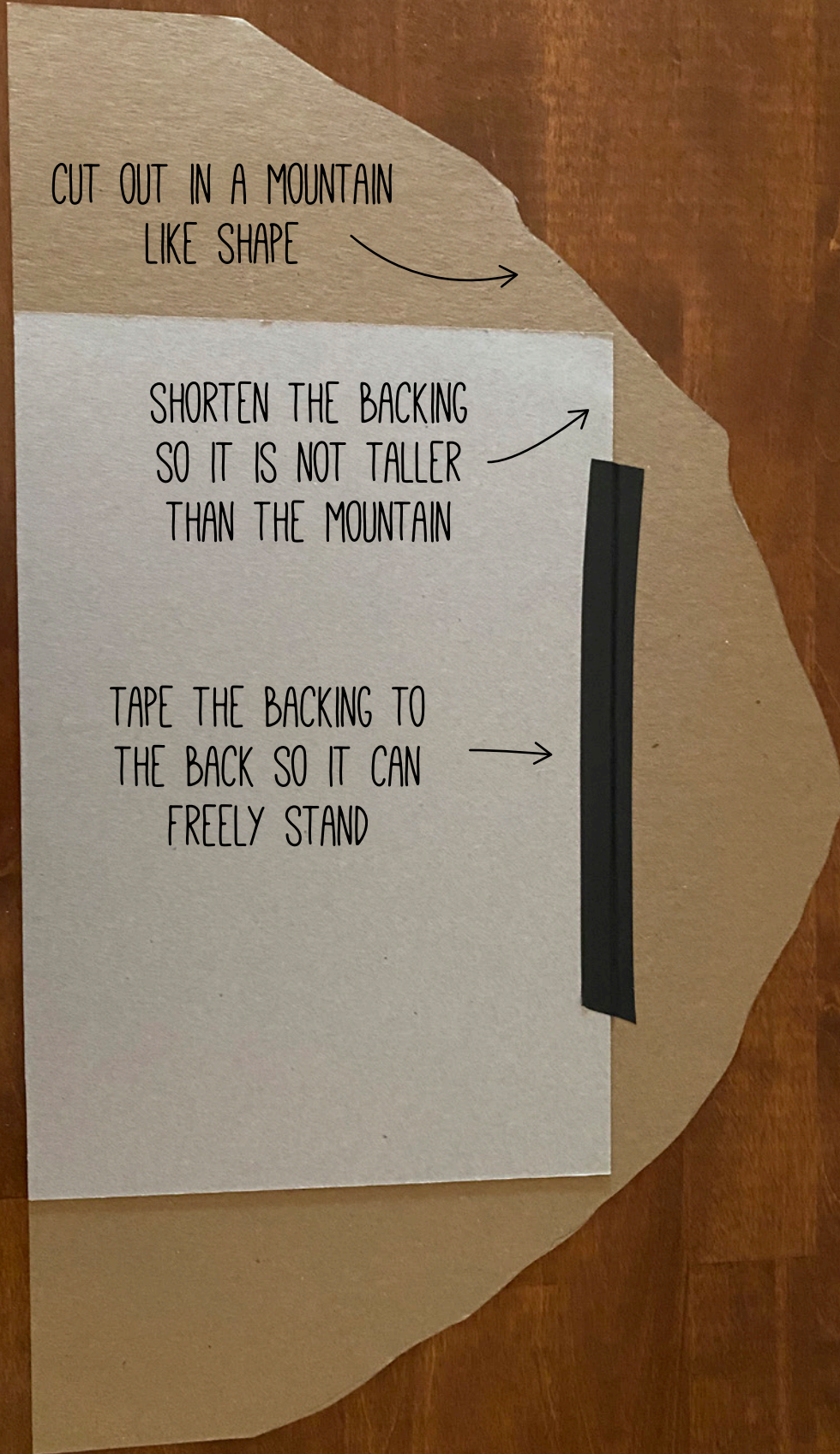

# PUPPETS

PRINT ON CARD STOCK  
& CUT OUT

TAPE

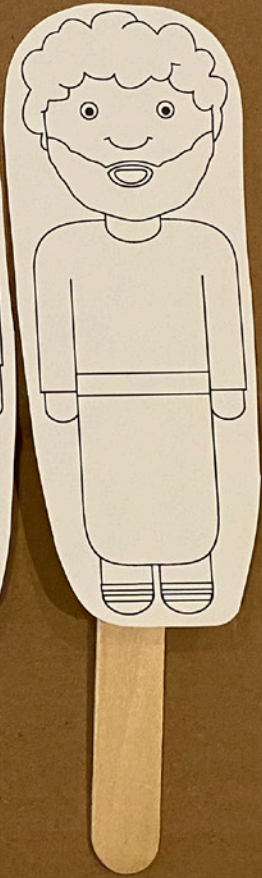
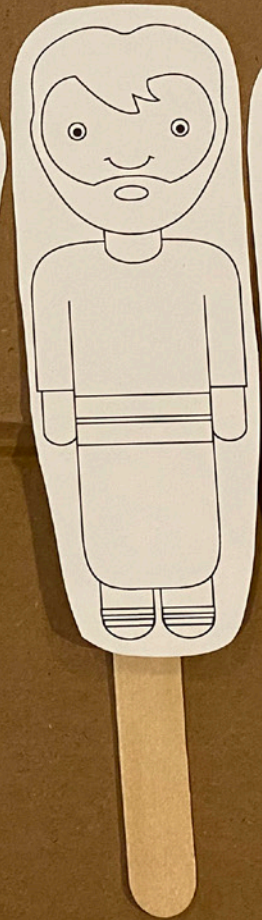
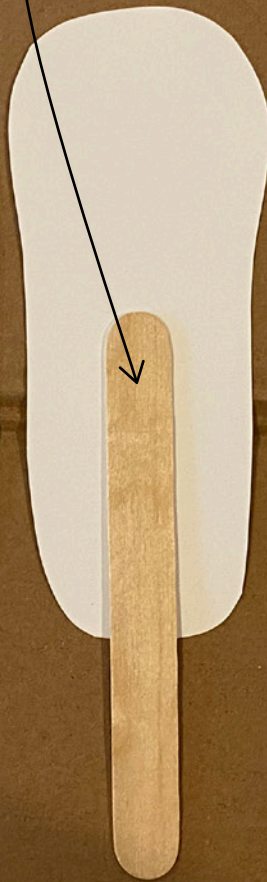
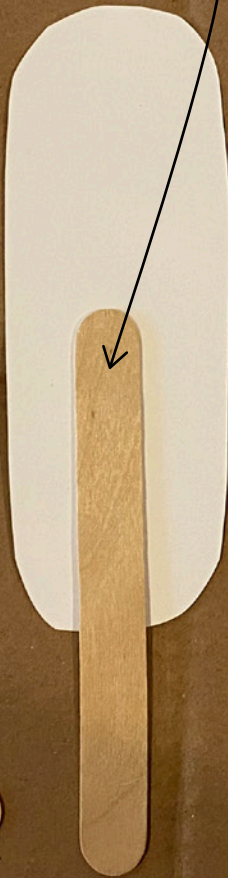
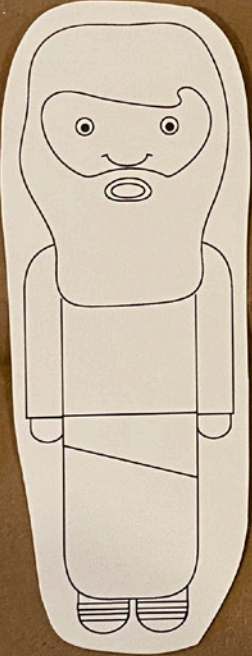
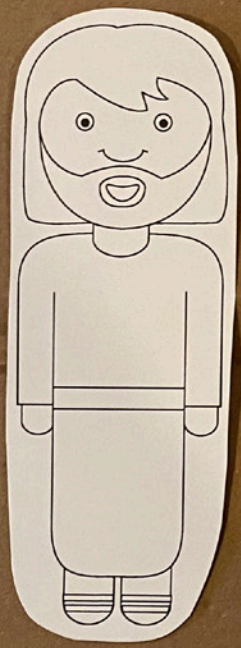

6 JUMBO POPSICLE STICKS

JOHN

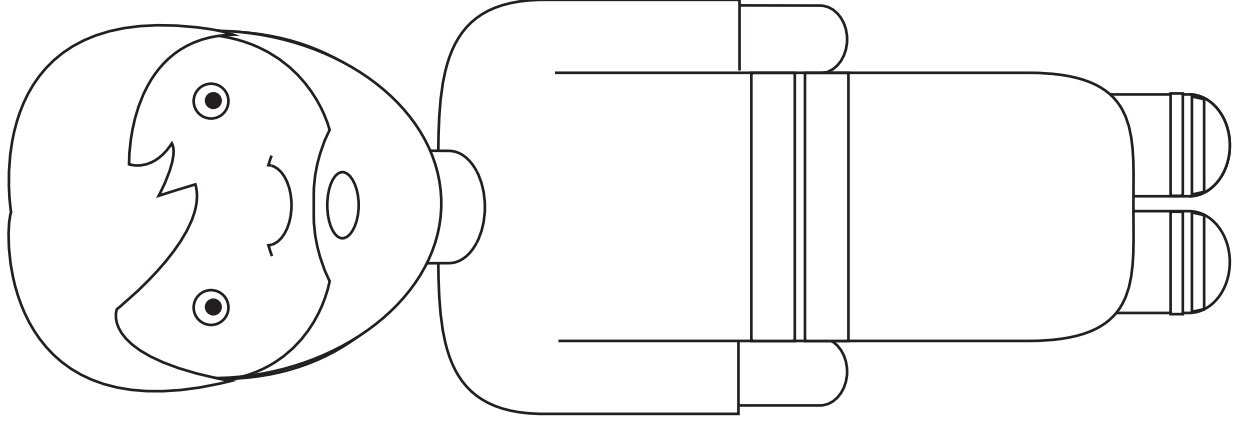

PETER

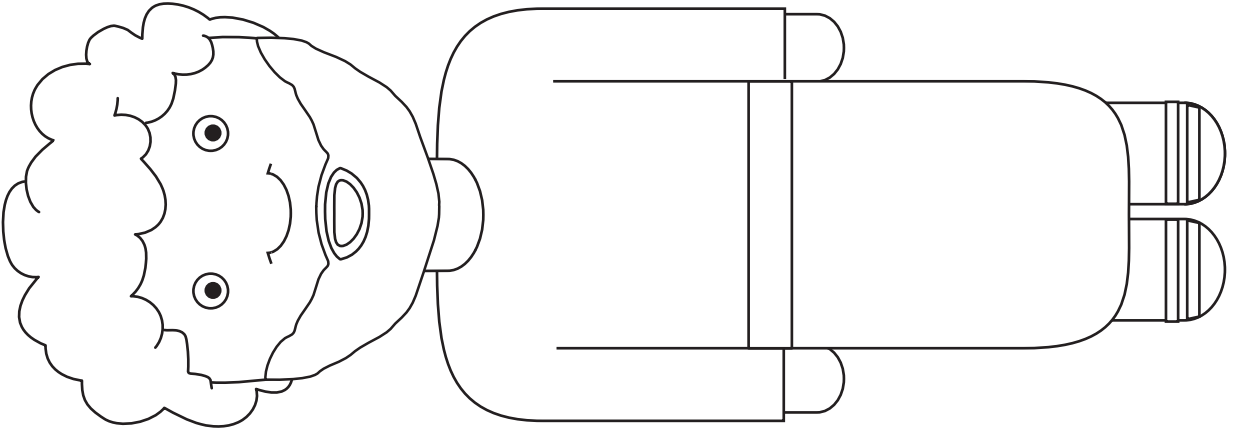

JESUS

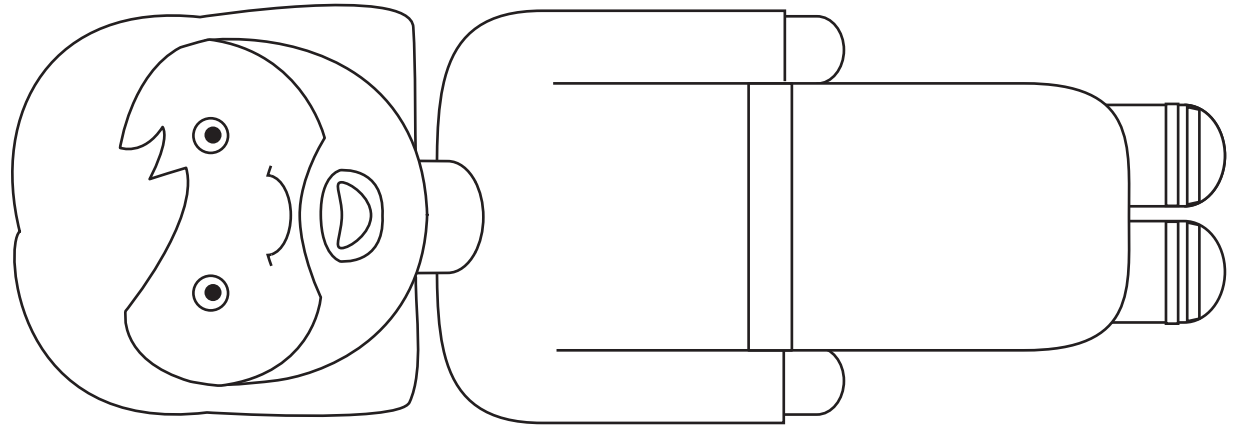

ELIJAH

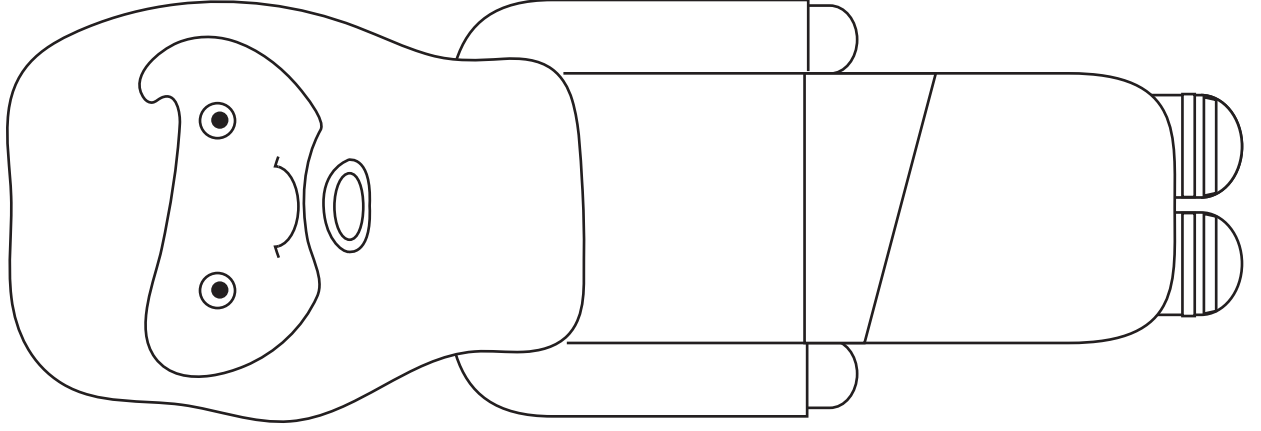

MOSES

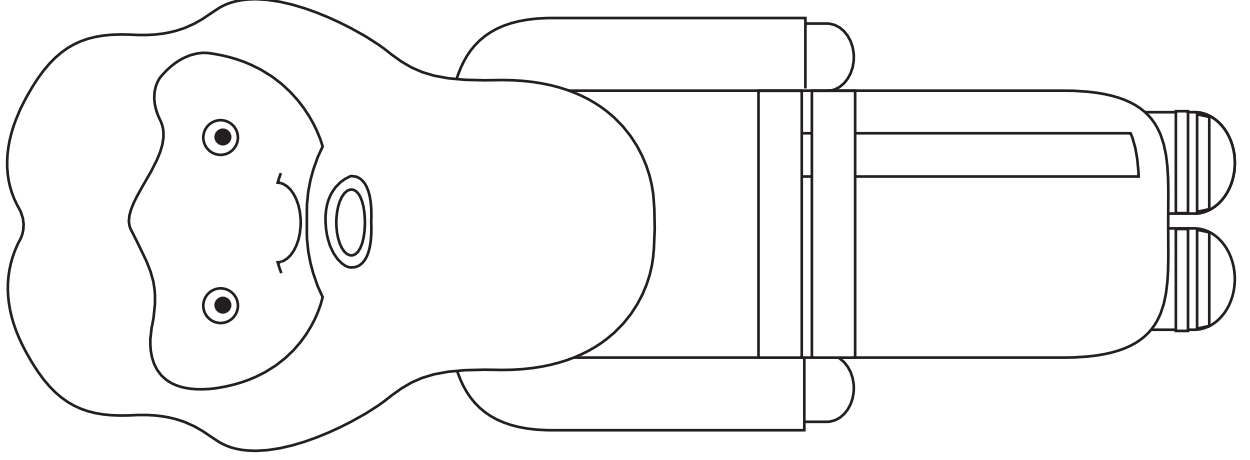

JAMES

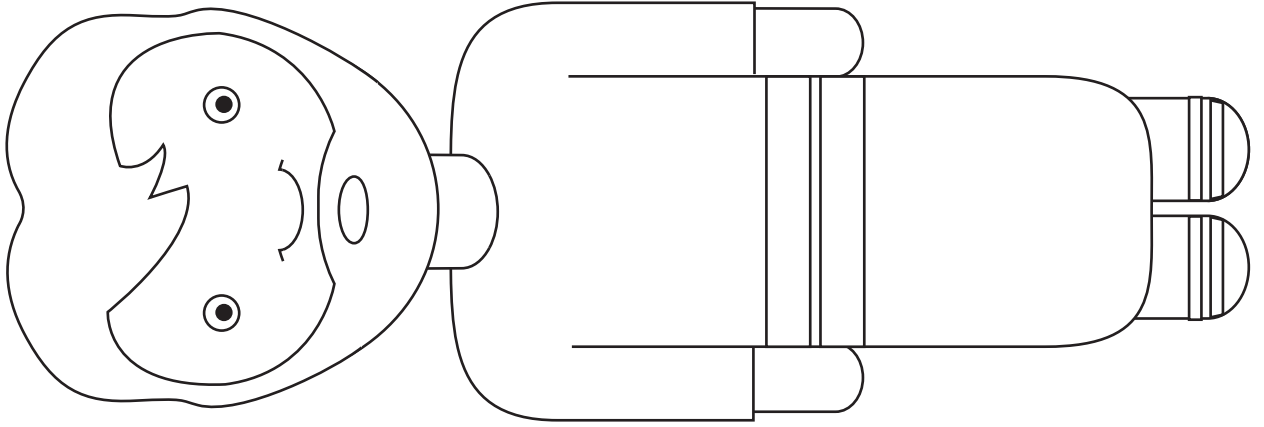

# TENTS

PRINT & CUT OUT

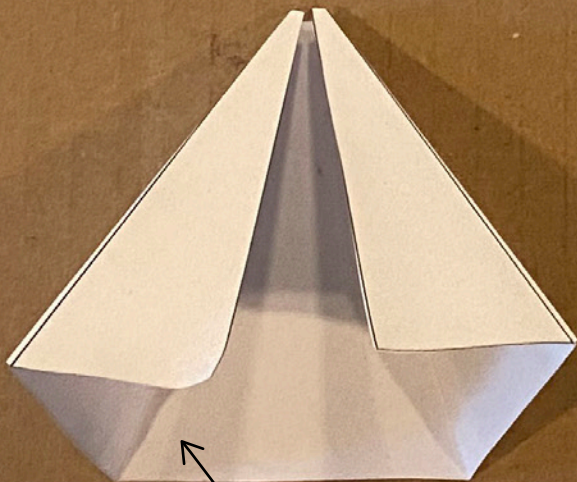
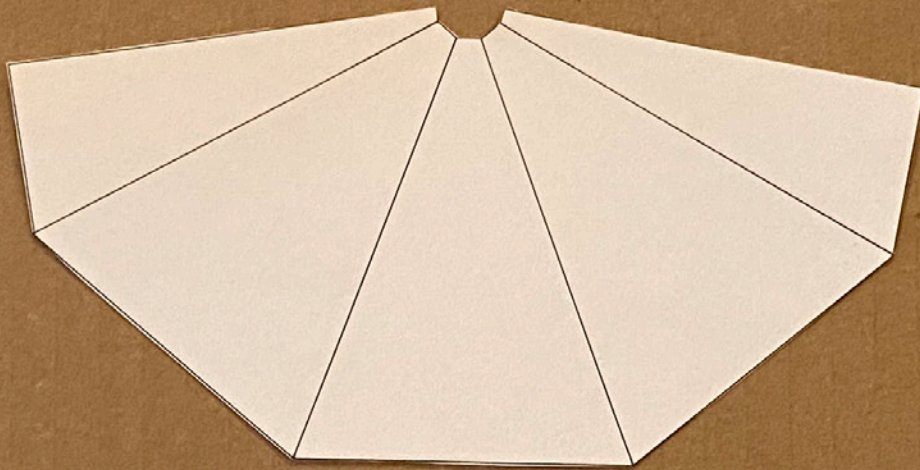

FOLD ALONG THE LINES  
TO FORM A TENT

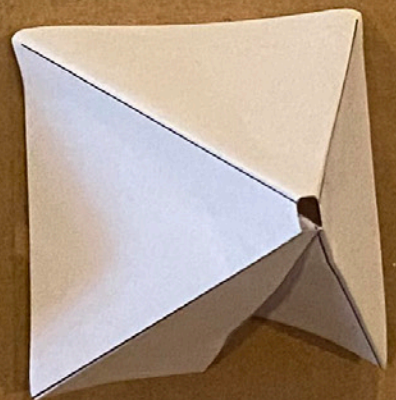
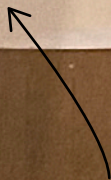

STAND UPRIGHT





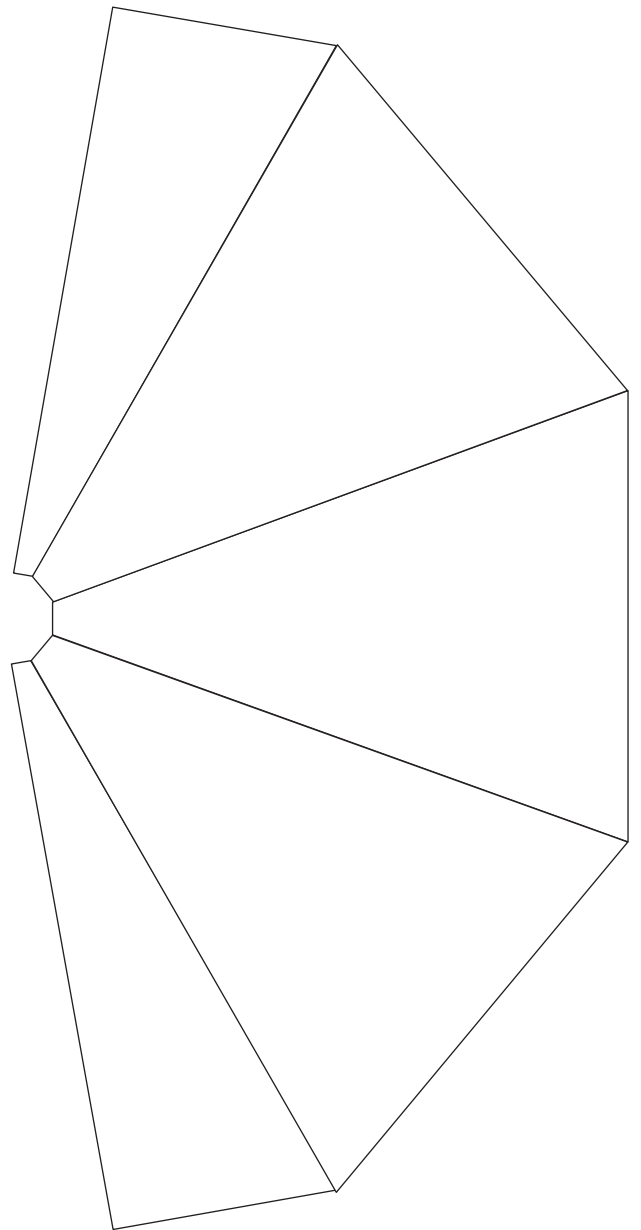
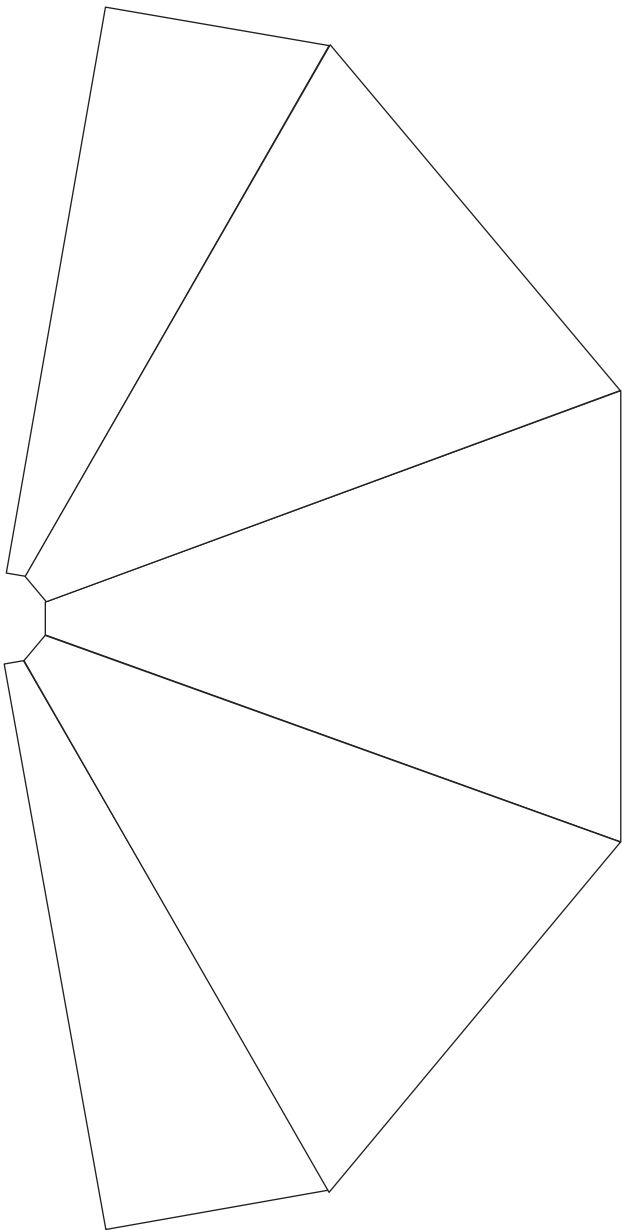
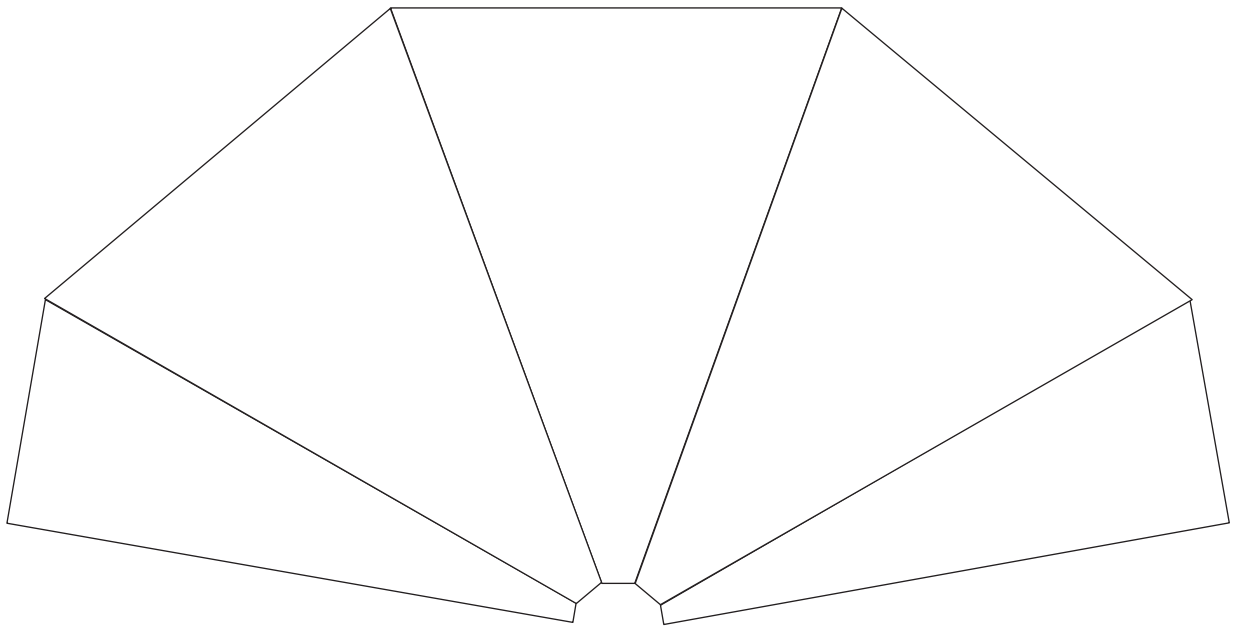

HE TOOK PETER, JOHN AND  
JAMES WITH HIM AND WENT UP  
ONTO A MOUNTAIN TO PRAY.

LUKE 9:28

HE TOOK PETER, JOHN AND  
JAMES WITH HIM AND WENT UP  
ONTO A MOUNTAIN TO PRAY.

LUKE 9:28

HE TOOK PETER, JOHN AND  
JAMES WITH HIM AND WENT UP  
ONTO A MOUNTAIN TO PRAY.

LUKE 9:28

HE TOOK PETER, JOHN AND  
JAMES WITH HIM AND WENT UP  
ONTO A MOUNTAIN TO PRAY.

LUKE 9:28