

DREAMS WEEK 2



DREAMS

DREAMS

JACOB'S LADDER

FOCUS

GENESIS 28:10-13 & 16-22

Jacob had a dream that he saw the gate of heaven!

MATERIALS

Jacob's Ladder picture

Luz, Beersheba & Harran signs

Stone (1 per child)

Staircase to heaven

Angel coloring page (1 per child)

What Did God Say? worksheet (1 per child)

House of God & Gate of Heaven signs

Oil (1 tsp per child)

Jacob's oath worksheet (1 per child)

10 small pieces of candy or crackers (1 set per child)

Crayons, scissors & tape

ACTIVITIES

1. INTRODUCTION

TALK: Ask the children if they know about Jacob's dream about the ladder!

ACTIVITY: Show children the Jacob's Ladder picture and hang nearby for them to see.



CORRESPONDING VERSE

2. LUZ

TALK: Jacob was all by himself and was on his way to Harran. It was too long of a journey to walk in one day so when the sun had set, he stopped. He found a stone and used it as a pillow and went to sleep.

ACTIVITY: Have children walk from Beersheba towards Harran, then tell them the sun has set and they need to stop at Luz and sleep so they can continue the next day. Then have them find a stone and lay down and use it as a pillow.

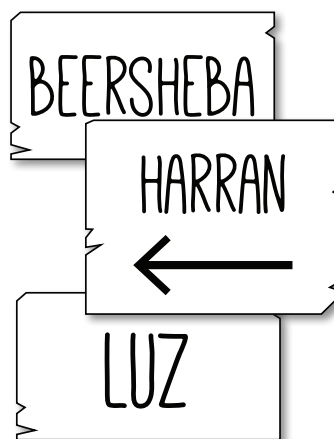

JACOB LEFT BEERSHEBA AND SET OUT FOR HARRAN. WHEN HE REACHED A CERTAIN PLACE, HE STOPPED FOR THE NIGHT BECAUSE THE SUN HAD SET. TAKING ONE OF THE STONES THERE, HE PUT IT UNDER HIS HEAD AND LAY DOWN TO SLEEP.

GENESIS 28:10-11

ACTIVITIES

3. LADDER TO THE CLOUDS

TALK: While Jacob was sleeping he had a dream! He saw a staircase resting on earth that reached all the way to heaven!

ACTIVITY: Show children a tall ladder with the top in the clouds.

4. ANGELS

TALK: Jacob had a dream where he saw a staircase going up to heaven! And angels of God were going up and down the staircase!

ACTIVITY: Have each child color an angel and tape it to the ladder.

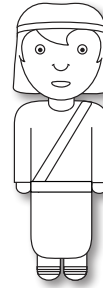

5. THE LORD

TALK: While the angels were going up and down the ladder he saw the Lord at the top of the stairs! The Lord told him who He was!

ACTIVITY: Have a voice say: "I am the Lord, the God of your father, Abraham, and the God of Isaac. I will give you and your descendants the land on which you are lying."

6. SPEAK

TALK: The Lord told Jacob amazing things! Jacob would have a family, and his family would grow large and have a lot of land! Everyone would be blessed because of him and his family. Plus the Lord would watch over him and would bring him back to Canaan!

ACTIVITY: Have the children circle what God said to Jacob, he would have a big family, lots of land and bless the world!

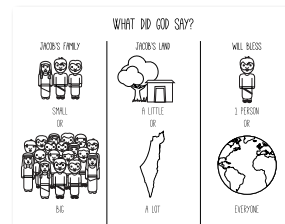

CORRESPONDING VERSE

HE HAD A DREAM IN WHICH HE SAW A STAIRWAY RESTING ON THE EARTH, WITH ITS TOP REACHING TO HEAVEN

GENESIS 28:12

THE ANGELS OF GOD WERE ASCENDING AND DESCENDING ON IT.

GENESIS 28:12

"THERE ABOVE IT STOOD THE LORD, AND HE SAID: "I AM THE LORD, THE GOD OF YOUR FATHER, ABRAHAM, AND THE GOD OF ISAAC. I WILL GIVE YOU AND YOUR DESCENDANTS THE LAND ON WHICH YOU ARE LYING."

GENESIS 28:13

"YOUR DESCENDANTS WILL BE LIKE THE DUST OF THE EARTH, AND YOU WILL SPREAD OUT TO THE WEST AND TO THE EAST, TO THE NORTH AND TO THE SOUTH. ALL PEOPLES ON EARTH WILL BE BLESSED THROUGH YOU AND YOUR OFFSPRING. I AM WITH YOU AND I WILL WATCH OVER YOU WHEREVER YOU GO, AND I WILL BRING YOU BACK TO THIS LAND. I WILL NOT LEAVE YOU UNTIL I HAVE DONE WHAT I HAVE PROMISED YOU."

GENESIS 28:13

ACTIVITIES

7. HOUSE OF GOD

TALK: Jacob had an amazing dream where he saw a staircase, and from the top of the staircase the Lord spoke amazing things to him! He woke up and said he was at the house of God and the gate of heaven!

ACTIVITY: Tape the House of God sign at the top of the stairs and the Gate of Heaven at the bottom.

8. BETHEL

TALK: Jacob took the stone he had slept on, set it up as a pillar and poured oil on top of it. He even renamed the city from Luz to Bethel!

ACTIVITY: Have children set up their stone and pour oil on it, then cross out Luz on the sign and write Bethel instead.

9. VOW

TALK: Jacob poured oil on the rock and renamed the place he was in. He even made a vow! He wanted God to do some things for him! He wanted God to watch over him and to give him food and clothes!

ACTIVITY: Fill in the missing words on the worksheet.

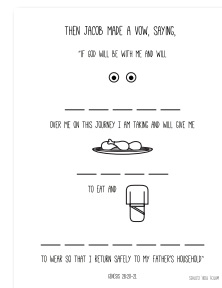

CORRESPONDING VERSE

WHEN JACOB AWOKE FROM HIS SLEEP, HE THOUGHT, "SURELY THE LORD IS IN THIS PLACE, AND I WAS NOT AWARE OF IT." HE WAS AFRAID AND SAID, "HOW AWESOME IS THIS PLACE! THIS IS NONE OTHER THAN THE HOUSE OF GOD; THIS IS THE GATE OF HEAVEN."

GENESIS 28:16-17

EARLY THE NEXT MORNING JACOB TOOK THE STONE HE HAD PLACED UNDER HIS HEAD AND SET IT UP AS A PILLAR AND POURED OIL ON TOP OF IT. HE CALLED THAT PLACE BETHEL, THOUGH THE CITY USED TO BE CALLED LUZ.

GENESIS 28:18-19

THEN JACOB MADE A VOW, SAYING, "IF GOD WILL BE WITH ME AND WILL WATCH OVER ME ON THIS JOURNEY I AM TAKING AND WILL GIVE ME FOOD TO EAT AND CLOTHES TO WEAR, SO THAT I RETURN SAFELY TO MY FATHER'S HOUSEHOLD"

GENESIS 28:20-21

ACTIVITIES

10. PROMOTED

TALK: Jacob wanted some things from God, but if God did it, then Jacob promised God would always be his God. Plus he would give the Lord a tenth of whatever God gave him!

ACTIVITY: Fold the previous worksheet in half and have the children write "Oath" on it. Then give each child 10 pieces of candy/crackers, and have them give one back as a tenth to give back to God.

OPTIONAL: Hand out each child a bible verse to take home.

CORRESPONDING VERSE

"THEN THE LORD WILL BE MY GOD, AND THIS STONE THAT I HAVE SET UP AS A PILLAR WILL BE GOD'S HOUSE, AND ALL THAT YOU GIVE ME I WILL GIVE YOU A TENTH."

GENESIS 28:21-22

HE HAD A DREAM IN WHICH HE SAW
A STAIRWAY RESTING ON THE EARTH
WITH ITS TOP REACHING TO HEAVEN

GENESIS 28:12

JACOB'S LADDER

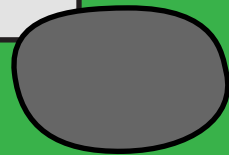
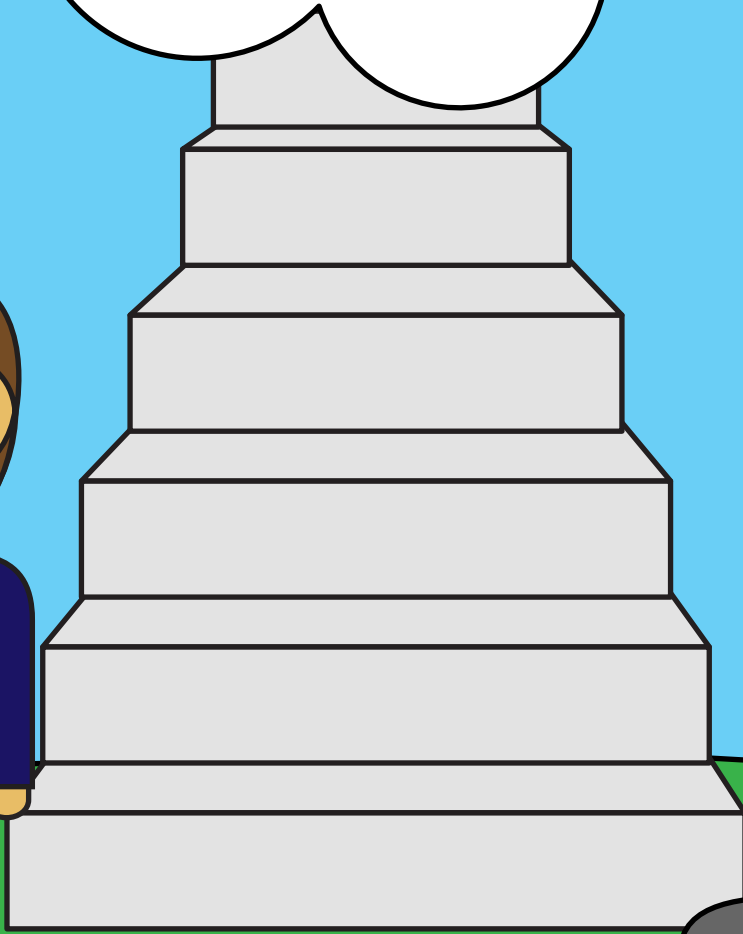
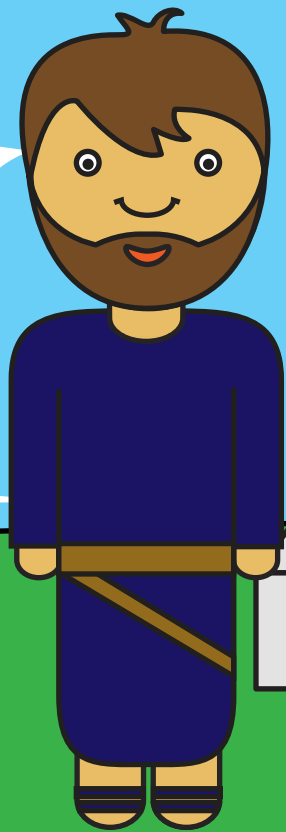

711

BEERSHEBA

HARRAN

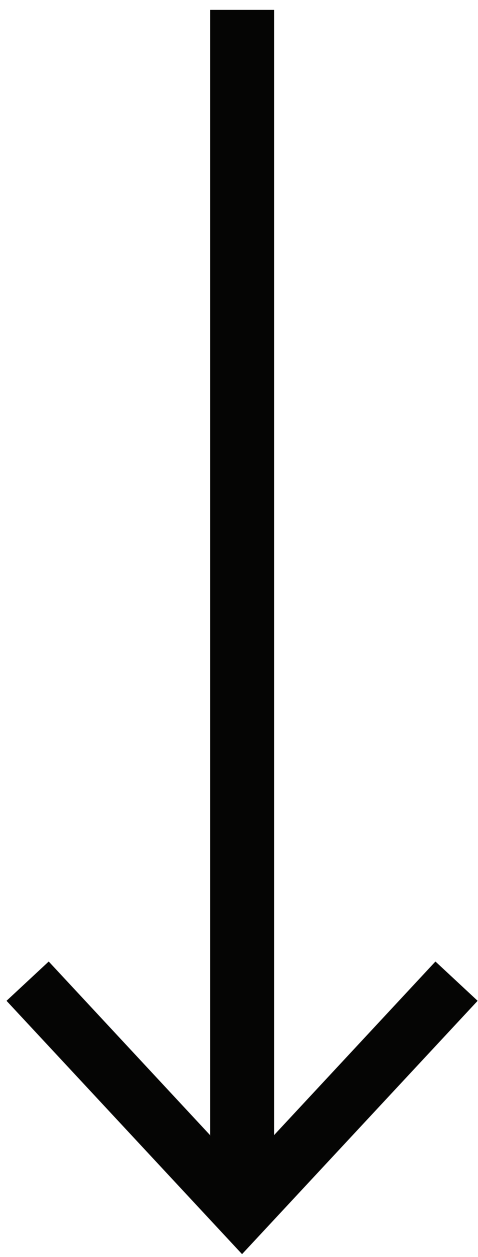

STAIRCASE

I set up a tall ladder then wrapped and taped a dark blue tablecloth to the front of the ladder.



STAIRCASE

Using 5", 12" and 260 balloons, I created a cloud and placed it on the top of the ladder. Then I placed large stones near the bottom.



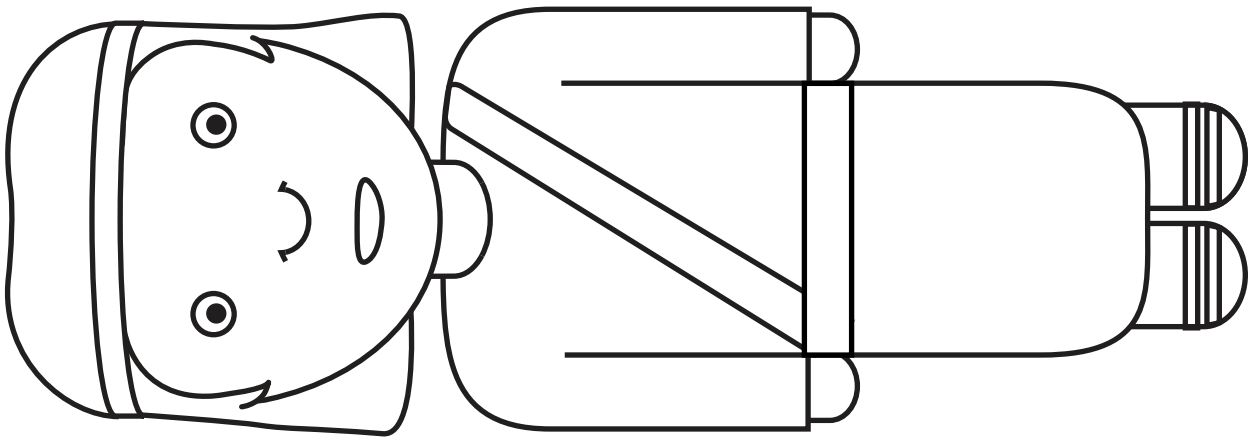
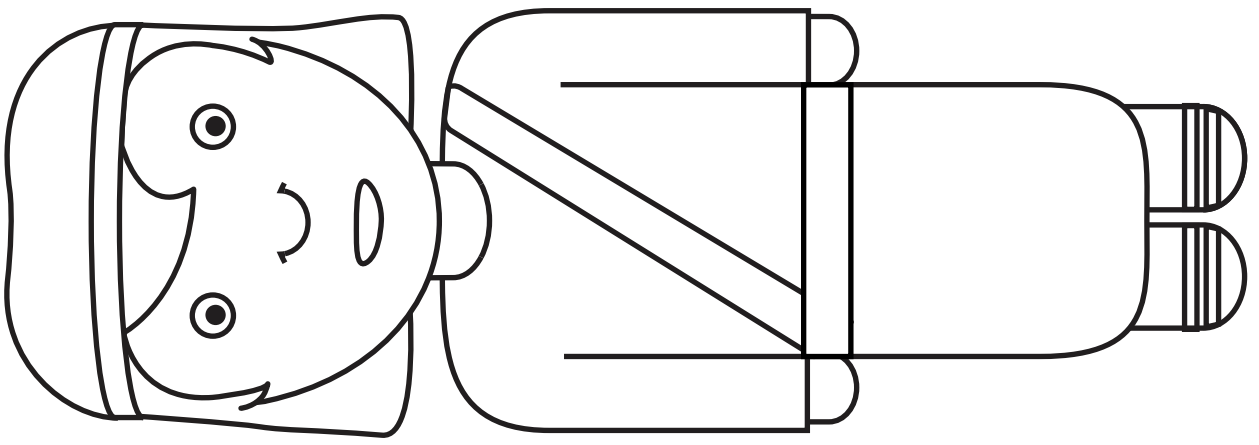
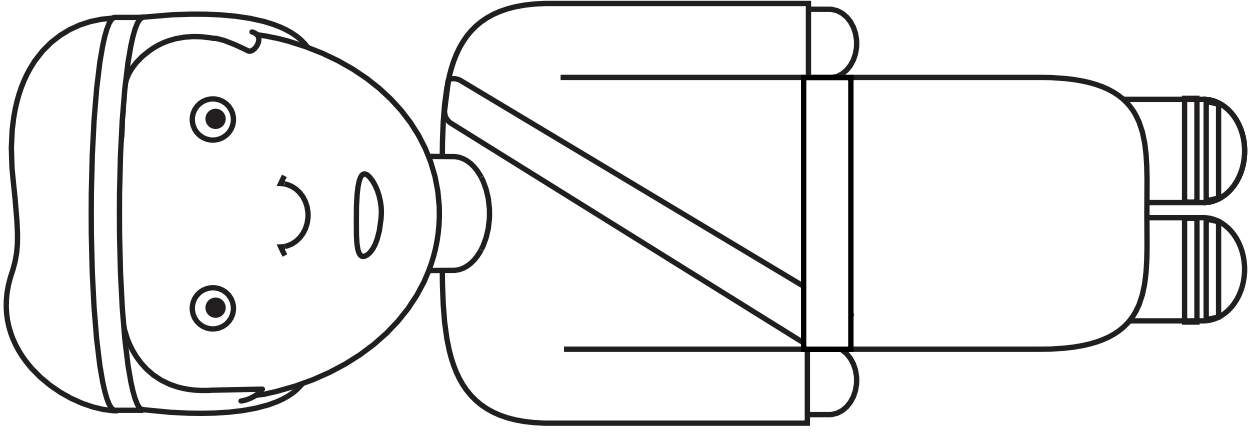

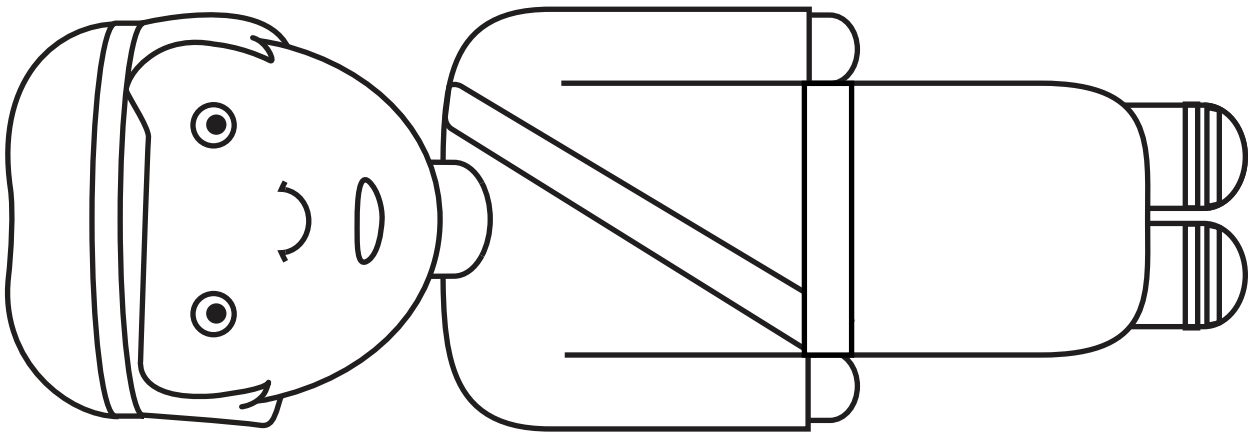
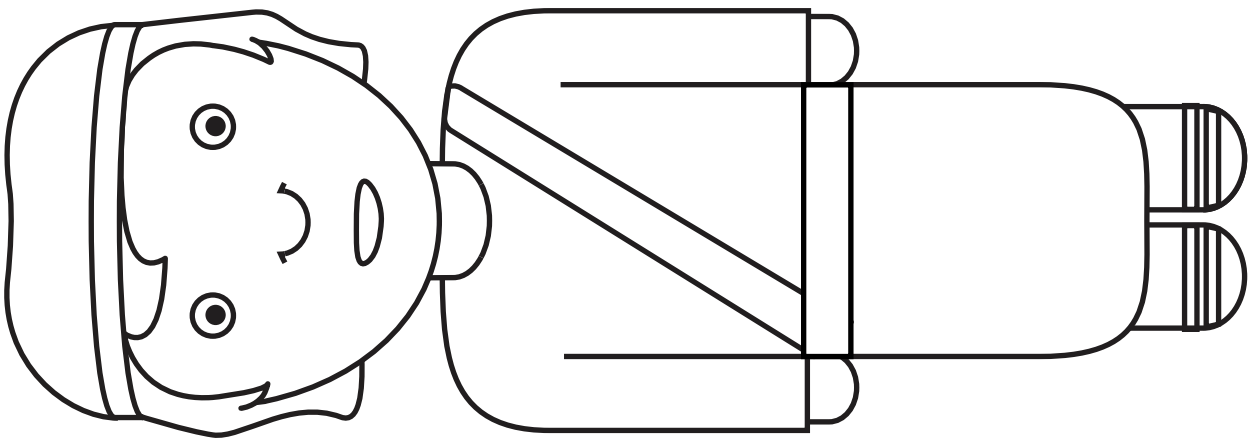
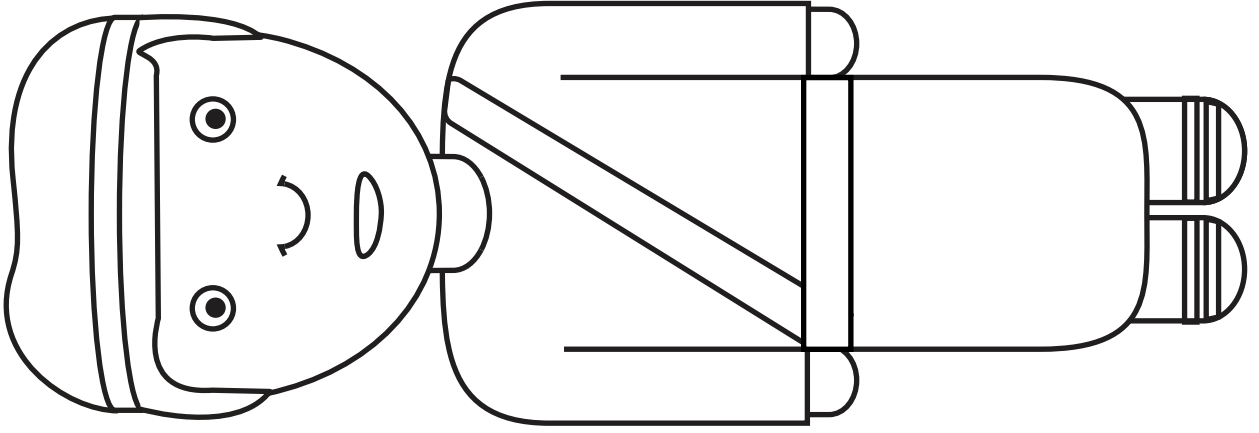

VOICE

ACTIVITY 5

I am the Lord, the God of your father, Abraham, and the God of Isaac. I will give you and your descendants the land on which you are lying.

VOICE

ACTIVITY 6

Jacob you will have a large family, and lots of land! Everyone will be blessed because of you and your family. Plus the I, the Lord will watch over you and will bring you back home to Canaan!

WHAT DID GOD SAY?

JACOB'S FAMILY

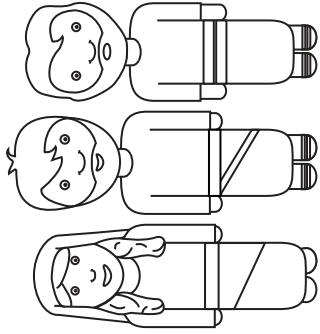

SMALL

OR

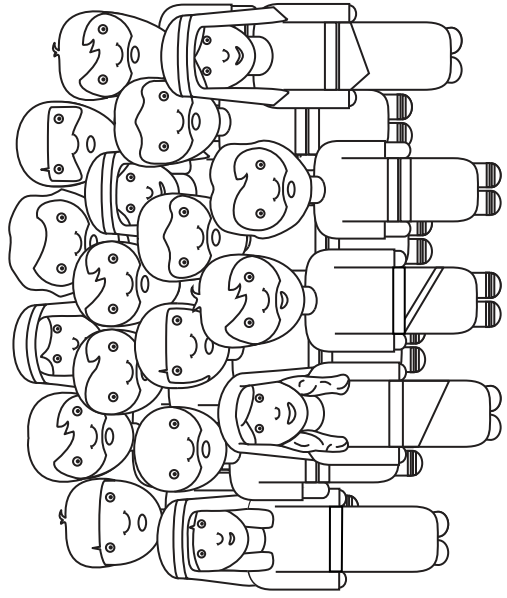

BIG

JACOB'S LAND

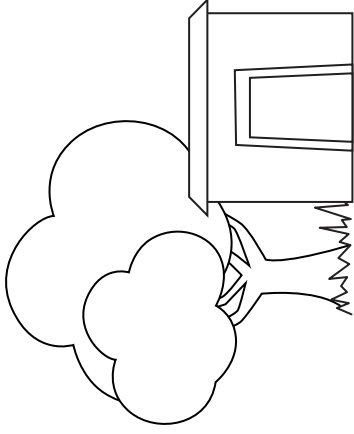

A LITTLE

OR



A LOT

WILL BLESS

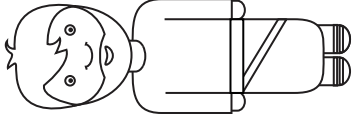

1 PERSON

OR

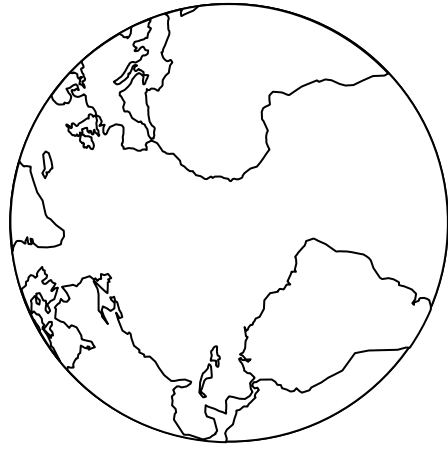

EVERYONE

HOUSE OF GOD

GATE OF HEAVEN

THEN JACOB MADE A VOW, SAYING,

"IF GOD WILL BE WITH ME AND WILL



OVER ME ON THIS JOURNEY I AM TAKING AND WILL GIVE ME



TO EAT AND

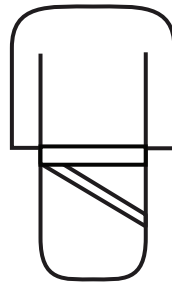

TO WEAR SO THAT I RETURN SAFELY TO MY FATHER'S HOUSEHOLD"

HE HAD A DREAM IN WHICH HE SAW
A STAIRWAY RESTING ON THE EARTH
WITH ITS TOP REACHING TO HEAVEN

GENESIS 28:12

HE HAD A DREAM IN WHICH HE SAW
A STAIRWAY RESTING ON THE EARTH
WITH ITS TOP REACHING TO HEAVEN

GENESIS 28:12

HE HAD A DREAM IN WHICH HE SAW
A STAIRWAY RESTING ON THE EARTH
WITH ITS TOP REACHING TO HEAVEN

GENESIS 28:12

HE HAD A DREAM IN WHICH HE SAW
A STAIRWAY RESTING ON THE EARTH
WITH ITS TOP REACHING TO HEAVEN

GENESIS 28:12