

DAY 1

DREAMS

FIRST DREAM

FOCUS

GENESIS 41:1-4

Pharaoh had a dream about cows!

MATERIALS

Pharaoh's First Dream coloring page (1 per child)

ACTIVITY

COWS

TALK: While Joseph was in prison in Egypt, Pharaoh the ruler of Egypt had two dreams! The first dream was about 7 fat cows and 7 skinny cows!

ACTIVITY: Today let's read Genesis 41:1-4 and fold, then go over and color the coloring about about Pharaoh's first dream!

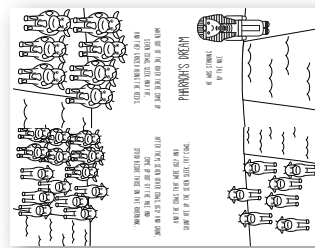

CORRESPONDING VERSE

WHEN TWO FULL YEARS HAD PASSED, PHARAOH HAD A DREAM. HE WAS STANDING BY THE NILE, WHEN OUT OF THE RIVER THERE CAME UP SEVEN COWS, SLEEK AND FAT, AND THEY GRAZED ALONG THE REEDS. AFTER THEM, SEVEN OTHER COWS, UGLY AND GAUNT, CAME UP OUT OF THE NILE AND STOOD BESIDE THOSE ON THE RIVERBANK. AND THE COWS THAT WERE UGLY AND GAUNT ATE UP THE SEVEN SLEEK, FAT COWS. THEN PHARAOH WOKE UP.

GENESIS 41:1-4

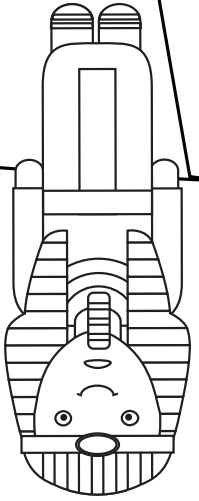

HE WAS STANDING
BY THE NILE

PHARAOH'S DREAM

WHEN OUT OF THE RIVER THERE CAME UP
SEVEN COWS, SLEEK AND FAT,
AND THEY GRAZED ALONG THE REEDS.

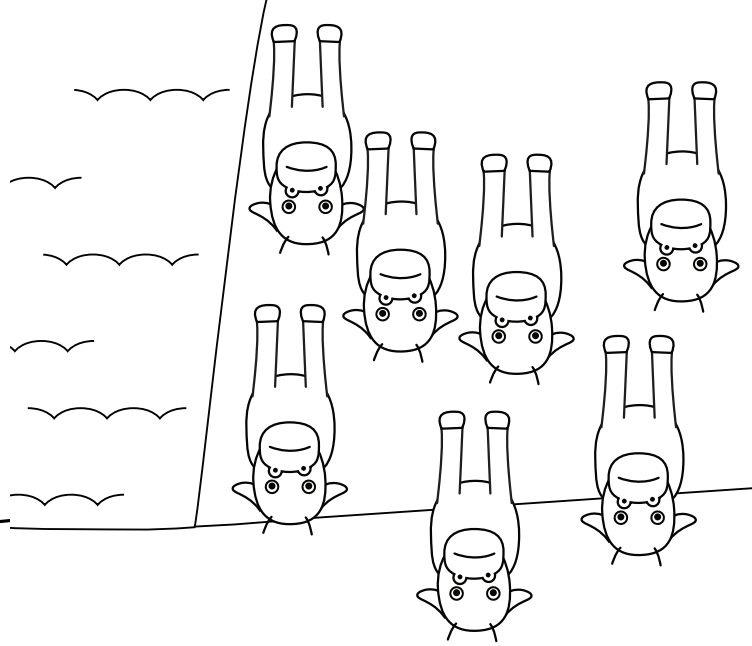
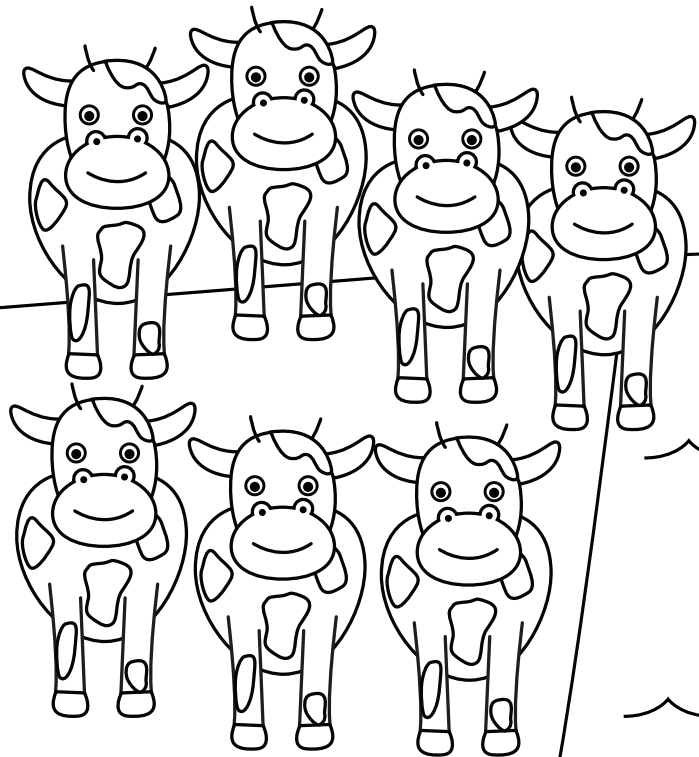

AND THE COWS THAT WERE UGLY AND
GAUNT ATE UP THE SEVEN SLEEK, FAT COWS.

AFTER THEM, SEVEN OTHER COWS, UGLY AND GAUNT,
CAME UP OUT OF THE NILE AND
STOOD BESIDE THOSE ON THE RIVERBANK.

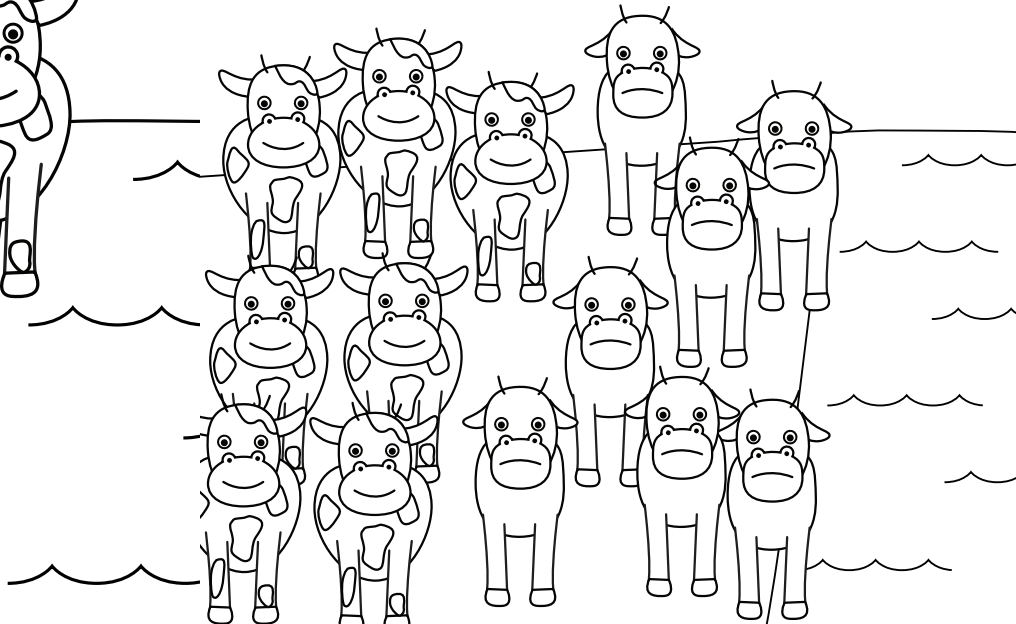

DAY 2

DREAMS

SECOND DREAM

FOCUS

GENESIS 41:5-7

Pharaoh had a second dream, this one was about grain!

MATERIALS

Pharaoh's Second Dream coloring page (1 per child)

ACTIVITY

GRAIN

TALK: The same night Pharaoh had a dream about cows, he had a dream about grain too! 7 heads of good grain and 7 heads of bad grain!

ACTIVITY: Today let's read Genesis 41:5-7, fold then color and go over Pharaoh's second dream!

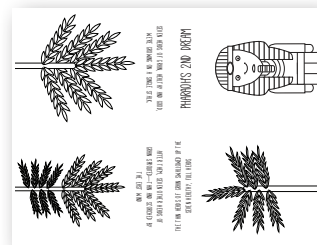

CORRESPONDING VERSE

HE FELL ASLEEP AGAIN AND HAD A SECOND DREAM: SEVEN HEADS OF GRAIN, HEALTHY AND GOOD, WERE GROWING ON A SINGLE STALK. AFTER THEM, SEVEN OTHER HEADS OF GRAIN SPROUTED—THIN AND SCORCHED BY THE EAST WIND. THE THIN HEADS OF GRAIN SWALLOWED UP THE SEVEN HEALTHY, FULL HEADS. THEN PHARAOH WOKE UP; IT HAD BEEN A DREAM.

GENESIS 41:5-7

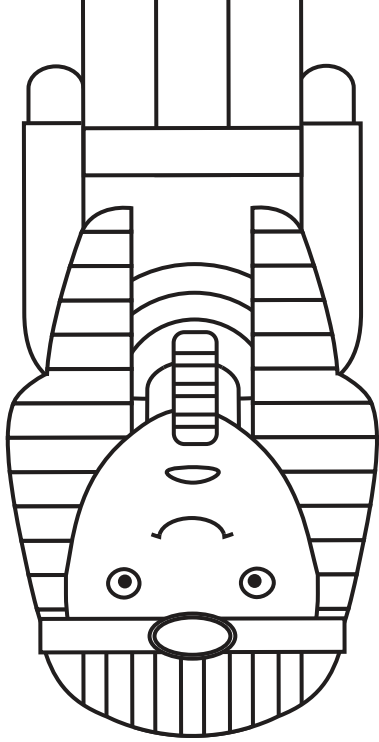

PHARAOH'S 2ND DREAM

SEVEN HEADS OF GRAIN, HEALTHY AND GOOD,
WE'RE GROWING ON A SINGLE STALK.

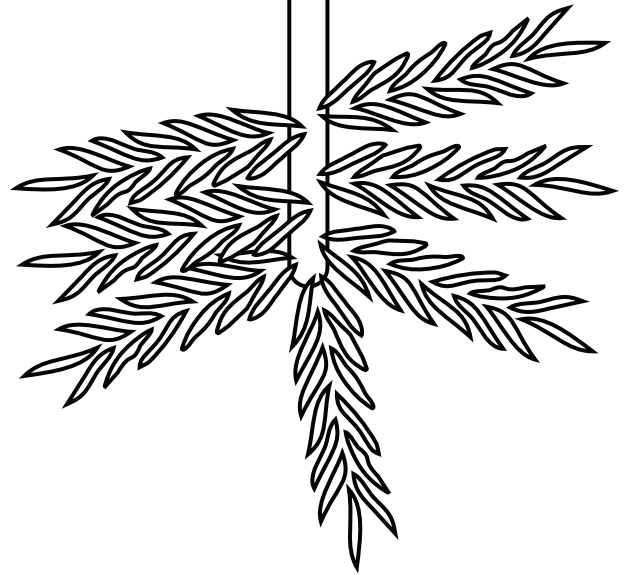
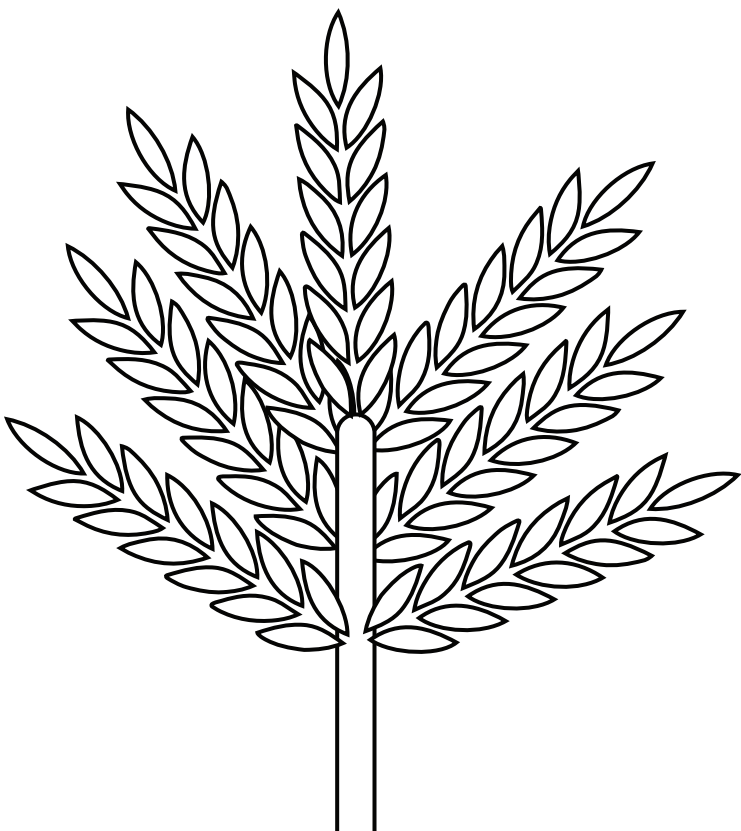

THE THIN HEADS OF GRAIN SWALLOWED UP THE
SEVEN HEALTHY, FULL HEADS

AFTER THEM, SEVEN OTHER HEADS OF
GRAIN SPROUTED—THIN AND SCORCHED BY
THE EAST WIND

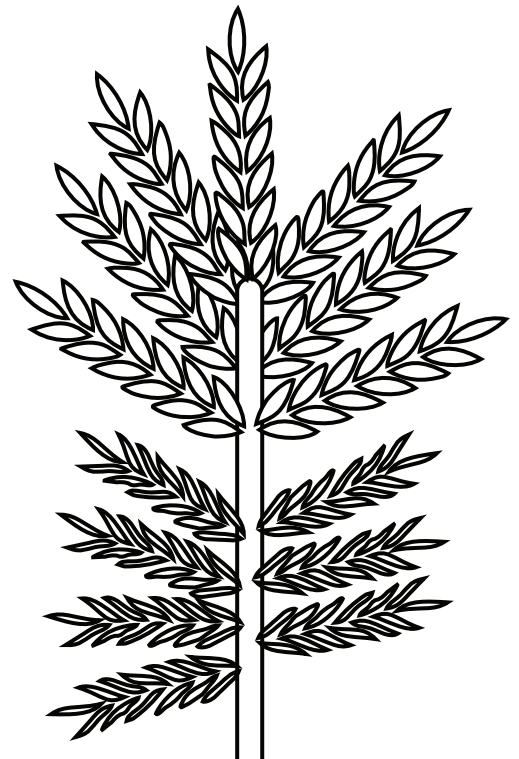

DAY 3

DREAMS

JOSEPH MEETS PHARAOH

FOCUS

GENESIS 41:8 & 14

Joseph met Pharaoh so he could tell him that his dreams meant!

MATERIALS

Joseph Meets Pharaoh coloring page (1 per child)

ACTIVITY

WHAT DO THEY MEAN?

TALK: Pharaoh had two dreams and he wanted to know what they meant! He asked all the wise men in his kingdom, but they couldn't help! Finally the cupbearer told him Joseph could tell him what his dreams meant! So Joseph got out of prison, changed his clothes and came before Pharaoh!

ACTIVITY: Today let's read Genesis 41:8 & 14 and color the coloring page of Joseph and Pharaoh!

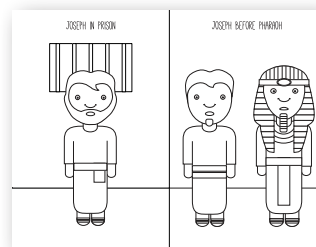

CORRESPONDING VERSE

IN THE MORNING HIS MIND WAS TROUBLED, SO HE SENT FOR ALL THE MAGICIANS AND WISE MEN OF EGYPT. PHARAOH TOLD THEM HIS DREAMS, BUT NO ONE COULD INTERPRET THEM FOR HIM... SO PHARAOH SENT FOR JOSEPH, AND HE WAS QUICKLY BROUGHT FROM THE DUNGEON. WHEN HE SHAVED AND CHANGED HIS CLOTHES, HE CAME BEFORE PHARAOH.

GENESIS 41:8 & 14

JOSEPH BEFORE PHARAOH

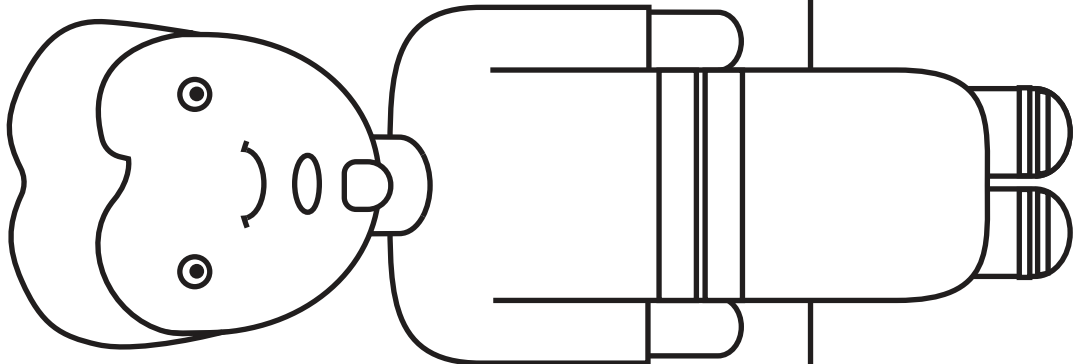
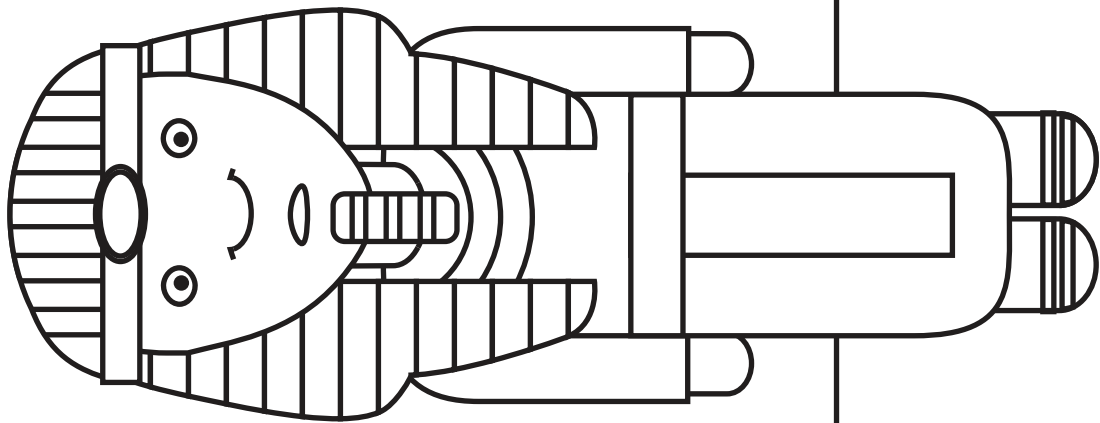

JOSEPH IN PRISON

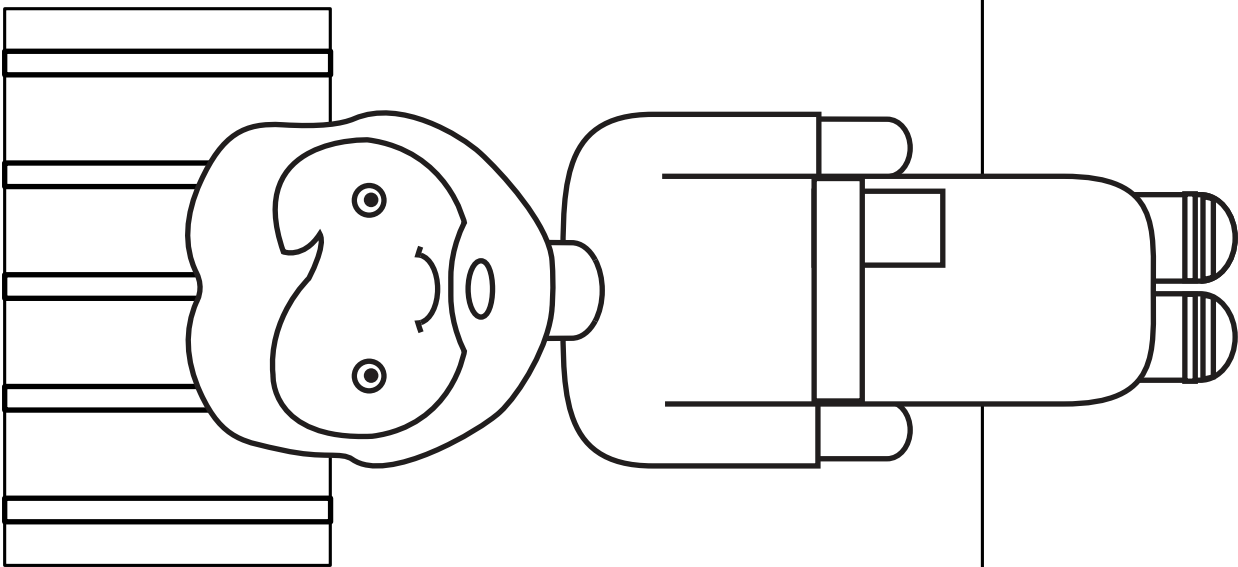

DAY 4

DREAMS

7 YEARS

FOCUS

GENESIS 41:25-27

Joseph told Pharaoh there would be 7 years of plenty followed by 7 years of not enough!

MATERIALS

7 small crackers & cup (1 set per child)

ACTIVITY

SAVE

TALK: Joseph told Pharaoh his dreams meant there would be 7 years of lots of food followed by 7 years of no food! And he needed to store the extra food in the first 7 years and save it for the other 7 years!

ACTIVITY: Today let's read Genesis 41:25-27 and grab 7 small crackers and a cup. Have your child place the crackers in the cup one at a time, representing the first 7 years. Explain that you were able to store away lots of food and now in the next 7, the years of no food, you get to eat what you saved! Then take out the crackers one by one, allowing your child to eat the cracker as you count out the year! Because they saved in the first 7 years, there was enough food for the last 7 years! They didn't go hungry!

CORRESPONDING VERSE

THEN JOSEPH SAID TO PHARAOH, "THE DREAMS OF PHARAOH ARE ONE AND THE SAME. GOD HAS REVEALED TO PHARAOH WHAT HE IS ABOUT TO DO. THE SEVEN GOOD COWS ARE SEVEN YEARS, AND THE SEVEN GOOD HEADS OF GRAIN ARE SEVEN YEARS; IT IS ONE AND THE SAME DREAM. THE SEVEN LEAN, UGLY COWS THAT CAME UP AFTERWARD ARE SEVEN YEARS, AND SO ARE THE SEVEN WORTHLESS HEADS OF GRAIN SCORCHED BY THE EAST WIND: THEY ARE SEVEN YEARS OF FAMINE."

GENESIS 41:25-27