

# TIME

## TIME

## THEN TO NOW

### FOCUS

GENESIS 2:7-7 & 20, 6:14 & 18-21, EXODUS 24:12,  
2 SAMUEL 5:7, PSALM 139:14, JOHN 14:12 & HEBREWS 11:9

We will create a timeline from the first man to your Tiny Arrow! Going over 6 important people from history; Adam, Noah, Abraham, Moses, David and Jesus!

### MATERIALS

Timeline coloring pages (1 set per child)  
Kinetic Sand (1 cup per child)  
Colors of the rainbow (1 set per child)  
Fort/tent  
10 Commandments coloring page (1 per child)  
Jesus Heals band aids (2-3 per child)  
Crayons & tape

### ACTIVITIES

#### 1. ADAM

**TALK:** In the beginning God created the heavens and the earth! Once the earth was full of plants and animals He created the first man and named him Adam! God made him from the dust of the earth! Adam even got to name the animals!

**ACTIVITY:** Help your Tiny Arrow form a man out of the kinetic sand, then blow in it like God did. Then have your Tiny Arrow color the Adam coloring page and name the animals they see!



### CORRESPONDING VERSE

THEN THE LORD GOD FORMED A MAN FROM THE DUST OF THE GROUND AND BREATHED INTO HIS NOSTRILS THE BREATH OF LIFE, AND THE MAN BECAME A LIVING BEING. NOW THE LORD GOD HAD PLANTED A GARDEN IN THE EAST, IN EDEN; AND THERE HE PUT THE MAN HE HAD FORMED.

GENESIS 2:7-8

SO THE MAN GAVE NAMES TO ALL THE LIVESTOCK, THE BIRDS IN THE SKY AND ALL THE WILD ANIMALS

GENESIS 2:20

## ACTIVITIES

### 2. NOAH

**TALK:** God asked Noah to build a big boat called an ark and he did! The ark saved some animals and Noah's family from a big flood! After the water went back down God showed Noah a rainbow and promised He would never flood the earth again!

**ACTIVITY:** Name the 7 colors of the **rainbow** with your Tiny Arrow and help them to put them in the correct order; red, orange, yellow, green, blue, indigo and violet. Then have your Tiny Arrow color the Noah page and draw a rainbow in the clouds above the ark and tape the paper next to the Adam page.

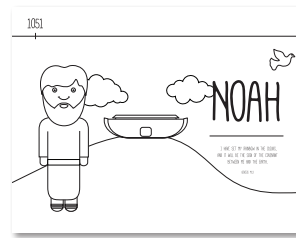

## CORRESPONDING VERSE

SO MAKE YOURSELF AN ARK OF CYPRESS WOOD... BUT I WILL ESTABLISH MY COVENANT WITH YOU, AND YOU WILL ENTER THE ARK—YOU AND YOUR SONS AND YOUR WIFE AND YOUR SONS' WIVES WITH YOU. YOU ARE TO BRING INTO THE ARK TWO OF ALL LIVING CREATURES.. YOU ARE TO TAKE EVERY KIND OF FOOD THAT IS TO BE EATEN AND STORE IT AWAY AS FOOD FOR YOU AND FOR THEM."

GENESIS 6:14 & 18-21

### 3. ABRAHAM

**TALK:** God promised Abraham that the land of Canaan would be his inheritance! Even though Abraham did not own any land yet and lived in tents, he still believed the land would be for him and his family!

**ACTIVITY:** Have your Tiny Arrow color the Abraham page on the timeline and tape it next to the Noah page. Then build a fort or tent to show them how Abraham lived!



BY FAITH HE MADE HIS HOME IN THE PROMISED LAND LIKE A STRANGER IN A FOREIGN COUNTRY; HE LIVED IN TENTS, AS DID ISAAC AND JACOB, WHO WERE HEIRS WITH HIM OF THE SAME PROMISE.

HEBREWS 11:9

### 4. MOSES

**TALK:** God gave Moses His law on a mountain! He even gave him 10 important laws called the 10 commandments on 2 tablets that the Israelites were suppose to follow!

**ACTIVITY:** Have your Tiny Arrow color the Moses page on the timeline and tape it next to the Abraham page. Then have your Tiny Arrow color and go over the **10 commandments coloring page**.

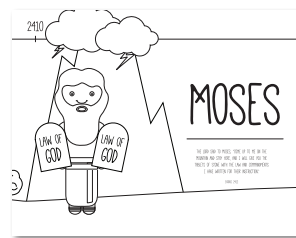

THE LORD SAID TO MOSES, "COME UP TO ME ON THE MOUNTAIN AND STAY HERE, AND I WILL GIVE YOU THE TABLETS OF STONE WITH THE LAW AND COMMANDMENTS I HAVE WRITTEN FOR THEIR INSTRUCTION."

EXODUS 24:12



## ACTIVITIES

### 5. DAVID

**TALK:** David was a shepherd, fighter and then a king of Israel! He ruled from a city called Jerusalem!

**ACTIVITY:** Help your Tiny Arrow color and assemble their **crown**. Then have them find and color the sheep, sword and crown on the David timeline and tape it next to the Moses page.

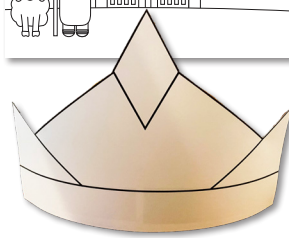
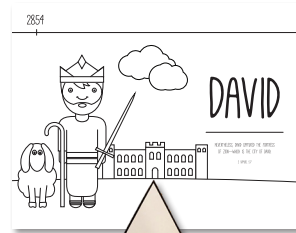

## CORRESPONDING VERSE

NEVERTHELESS, DAVID CAPTURED THE FORTRESS OF ZION—WHICH IS THE CITY OF DAVID.

2 SAMUEL 5:7

### 6. JESUS

**TALK:** Jesus is a descendant of David and the son of God! He did amazing things while He was here like healing people, setting the captives free and helping people to know God better! He even said that if we believe in Him we can do even greater things than He did!

**ACTIVITY:** Have your Tiny Arrow color the Jesus page on the timeline and tape it next to the David page. Then have them ask Jesus to heal someone who is sick or has a boo boo and give them a **Jesus Heals sticker!**

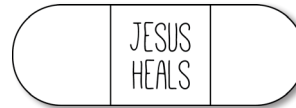
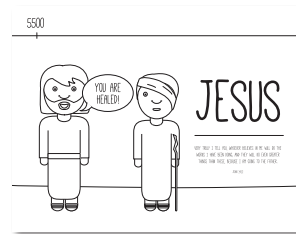

VERY TRULY I TELL YOU, WHOEVER BELIEVES IN ME WILL DO THE WORKS I HAVE BEEN DOING, AND THEY WILL DO EVEN GREATER THINGS THAN THESE, BECAUSE I AM GOING TO THE FATHER.

JOHN 14:12

### 7. YOU!

**TALK:** You are important to God! He created you like Adam. He has a job for you like Noah. He has promises for you like Abraham. He wants you follow His word like Moses. He wants you to be a king like David and to do what Jesus did!

**ACTIVITY:** Have your Tiny Arrow color and fill out the You! page on the timeline and tape it next to the Jesus page.

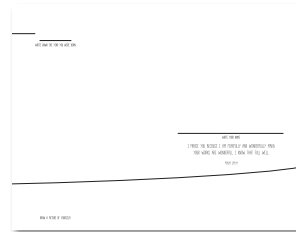

I PRAISE YOU BECAUSE I AM FEARFULLY AND WONDERFULLY MADE; YOUR WORKS ARE WONDERFUL, I KNOW THAT FULL WELL.

PSALM 139:14

**OPTIONAL:** Hand out each child a bible verse to take home.

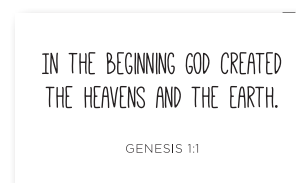

IN THE  
BEGINNING

# ADAM

SO THE MAN GAVE NAMES TO ALL  
THE LIVESTOCK, THE BIRDS IN THE SKY  
AND ALL THE WILD ANIMALS

GENESIS 2:20

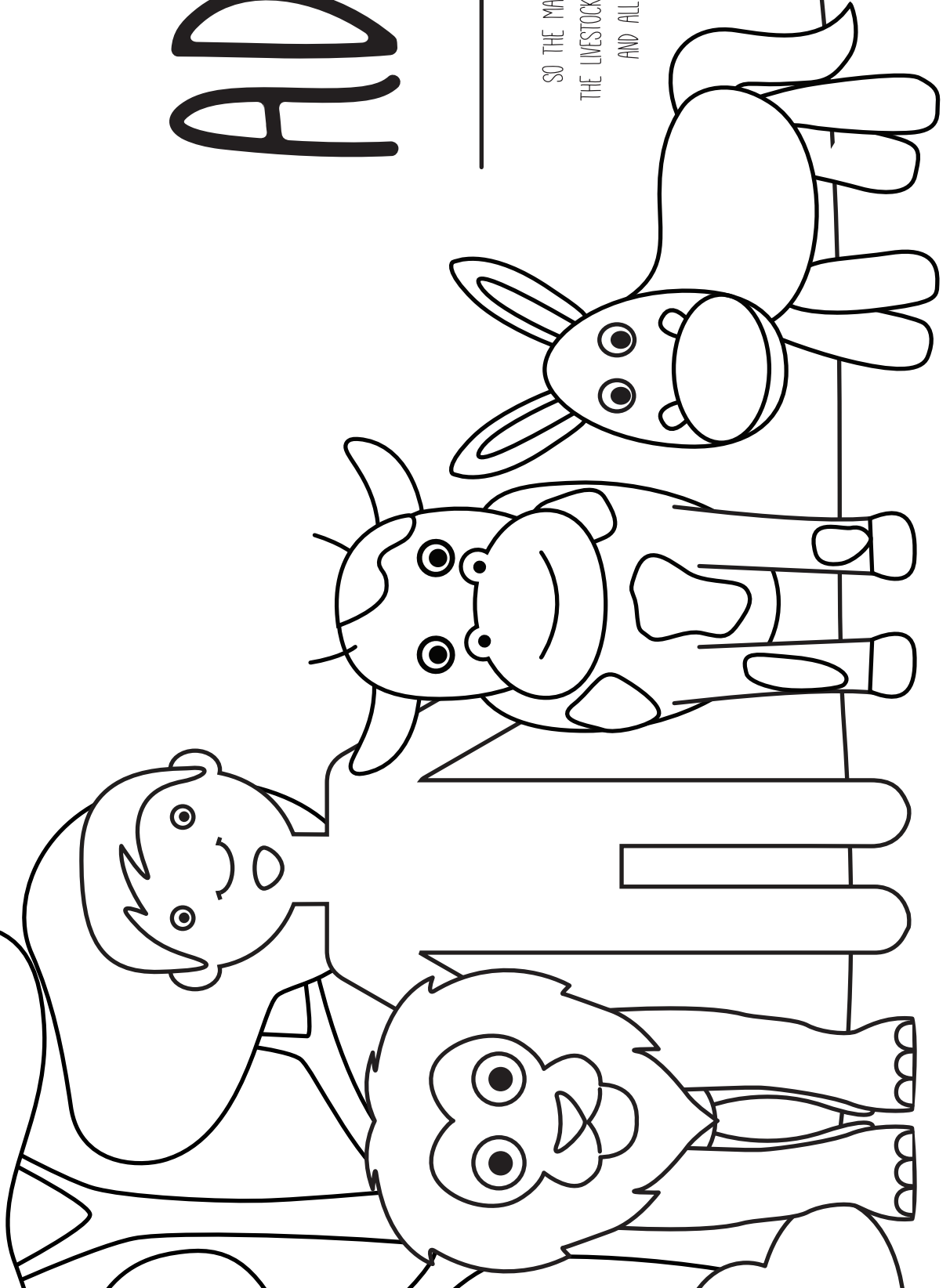

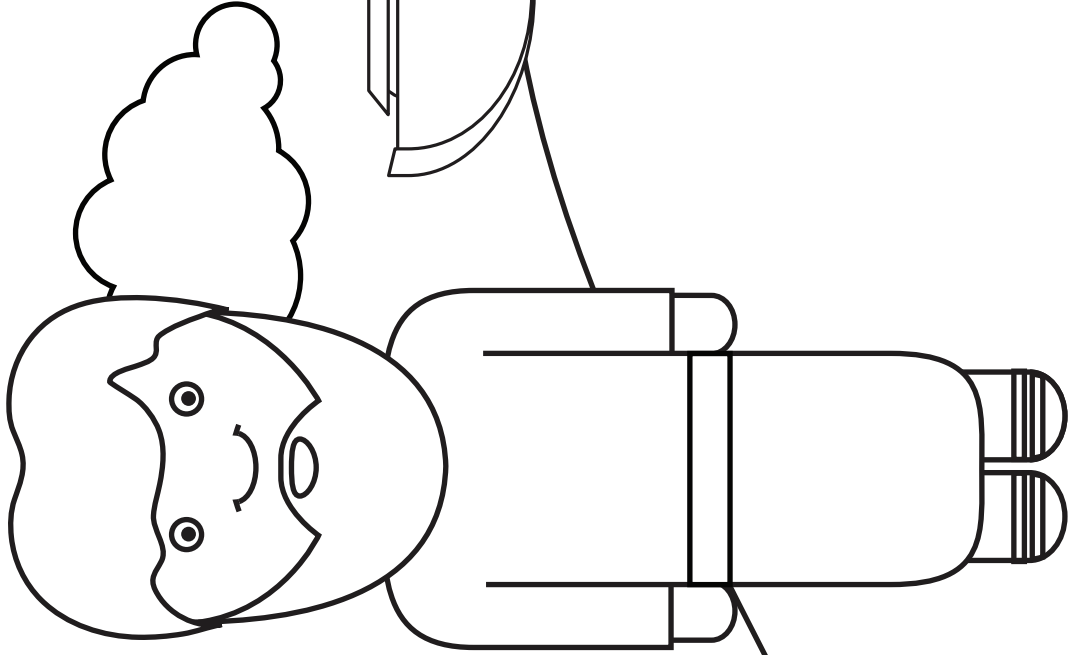

# NOAH



I HAVE SET MY RAINBOW IN THE CLOUDS,  
AND IT WILL BE THE SIGN OF THE COVENANT  
BETWEEN ME AND THE EARTH.

GENESIS 9:13

# RAINBOW

CUT OUT 4.5" X 6"  
SHEETS OF PAPER

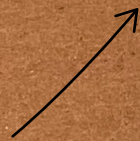

PLACE IN ORDER;  
RED, ORANGE, YELLOW, GREEN,  
BLUE, INDIGO & VIOLET

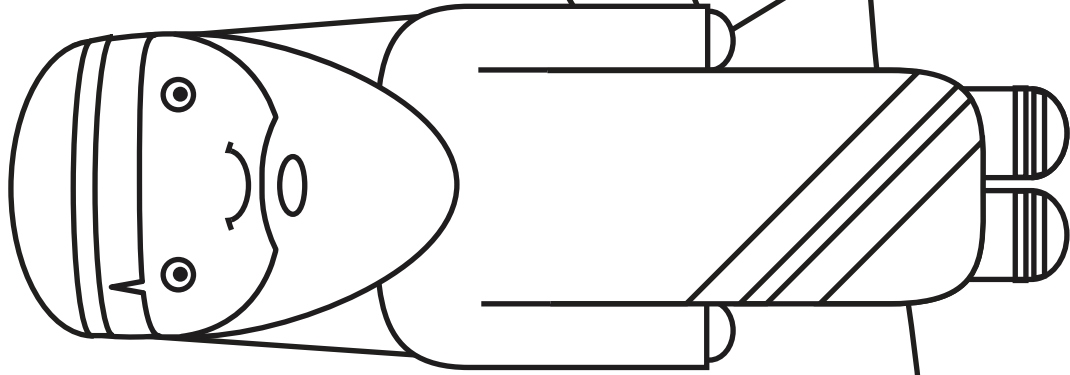

# ABRAHAM

BY FAITH HE MADE HIS HOME IN THE PROMISED LAND  
LIKE A STRANGER IN A FOREIGN COUNTRY; HE LIVED IN  
TENTS, AS DID ISAAC AND JACOB, WHO WERE HEIRS  
WITH HIM OF THE SAME PROMISE.

HEBREWS 11:9



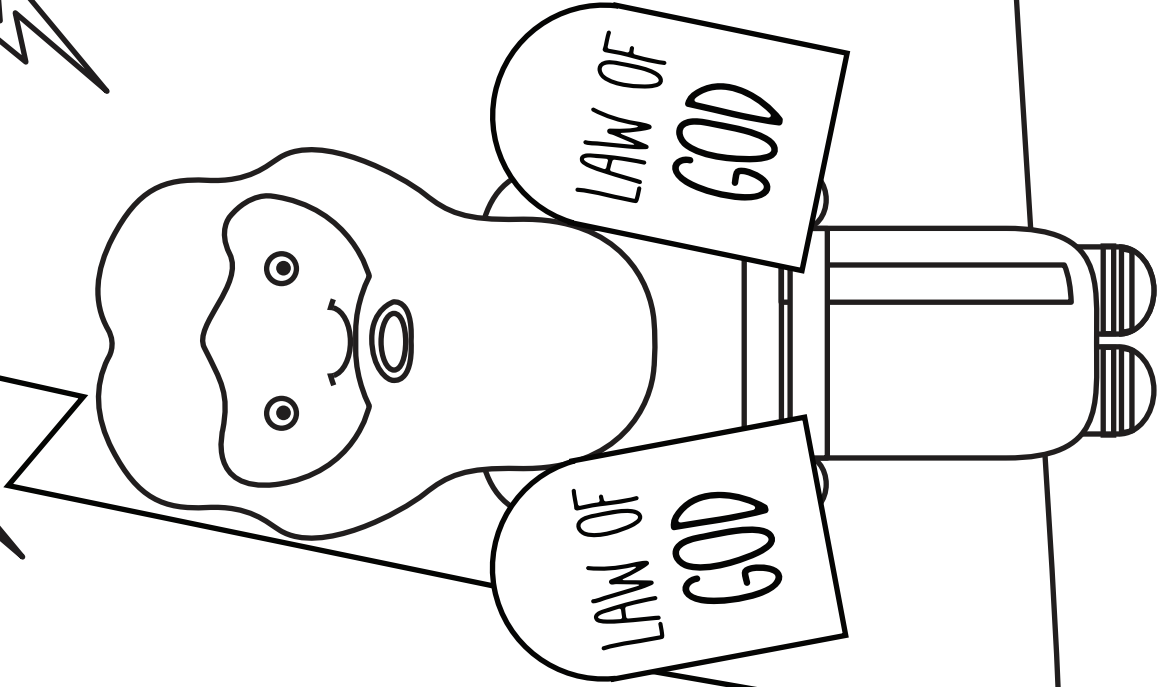

# MOSES

THE LORD SAID TO MOSES, "COME UP TO ME ON THE MOUNTAIN AND STAY HERE, AND I WILL GIVE YOU THE TABLETS OF STONE WITH THE LAW AND COMMANDMENTS I HAVE WRITTEN FOR THEIR INSTRUCTION."

EXODUS 24:12



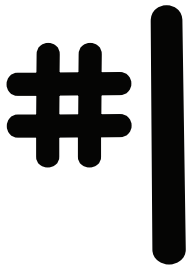

GOD IS #1

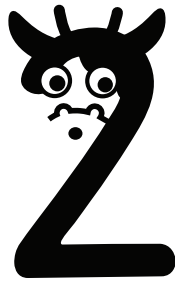

NO IDOLS



RESPECT GOD'S NAME

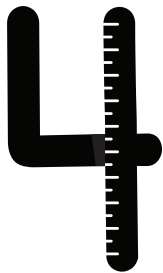

KEEP THE SABBATH HOLY



HONOR YOUR PARENTS



DO NOT KILL

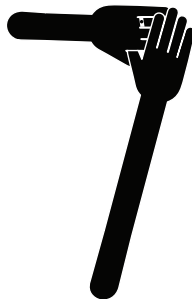

DO NOT COMMIT ADULTERY

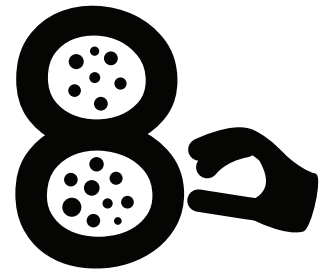

DO NOT STEAL

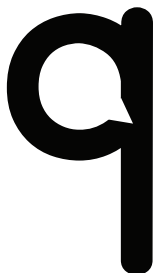

DO NOT LIE

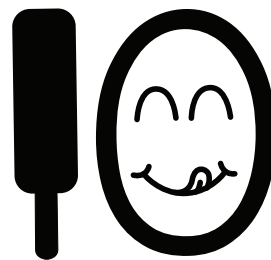

DO NOT COVET

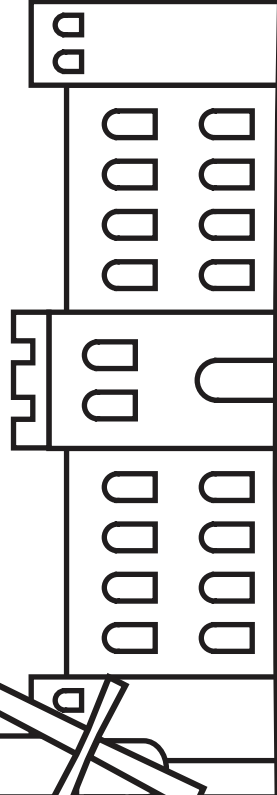
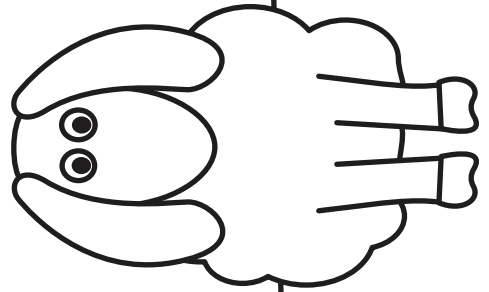
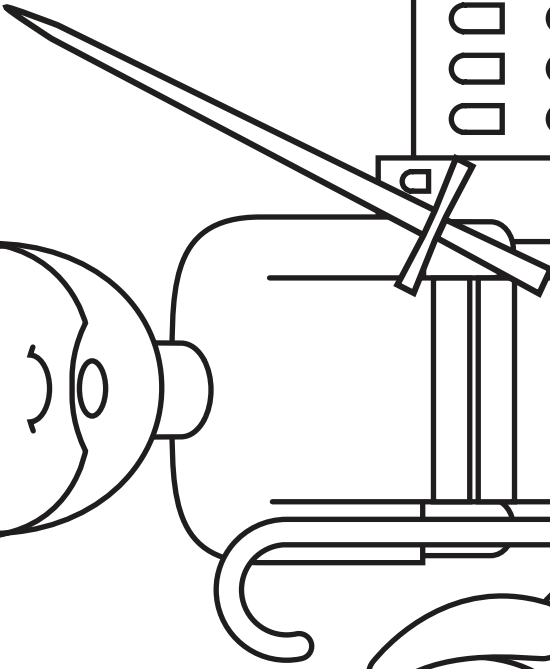
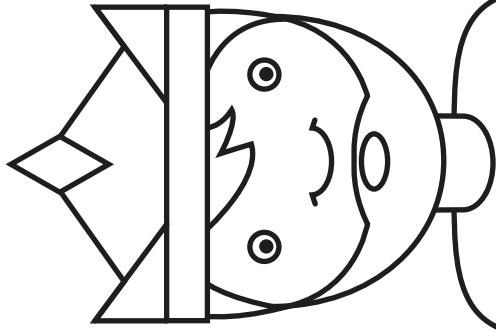
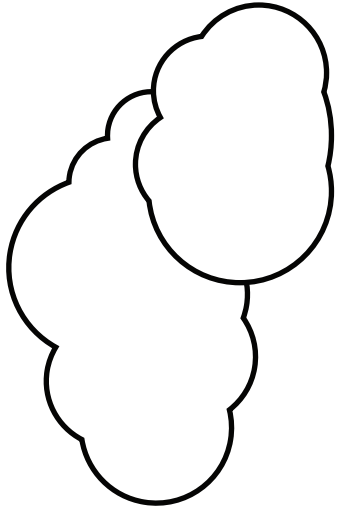

# DAVID

---

NEVERTHELESS, DAVID CAPTURED THE FORTRESS  
OF ZION—WHICH IS THE CITY OF DAVID.

2 SAMUEL 5:7

# CROWN

PRINT ON CARDSTOCK  
& CUT OUT CROWN &  
1" BANDS

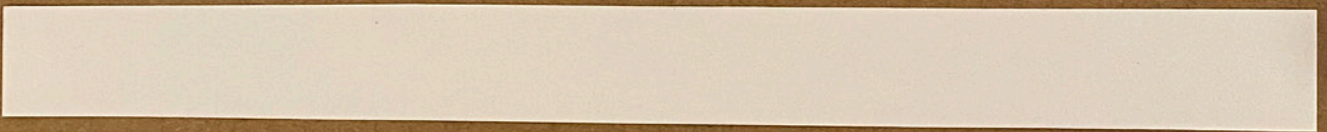
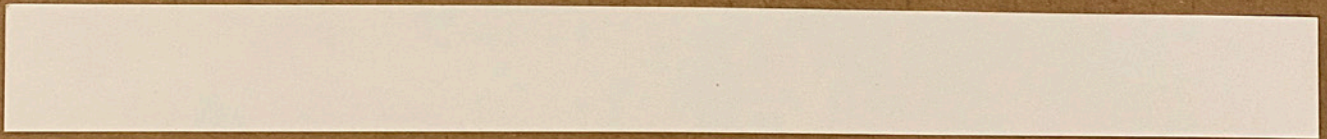
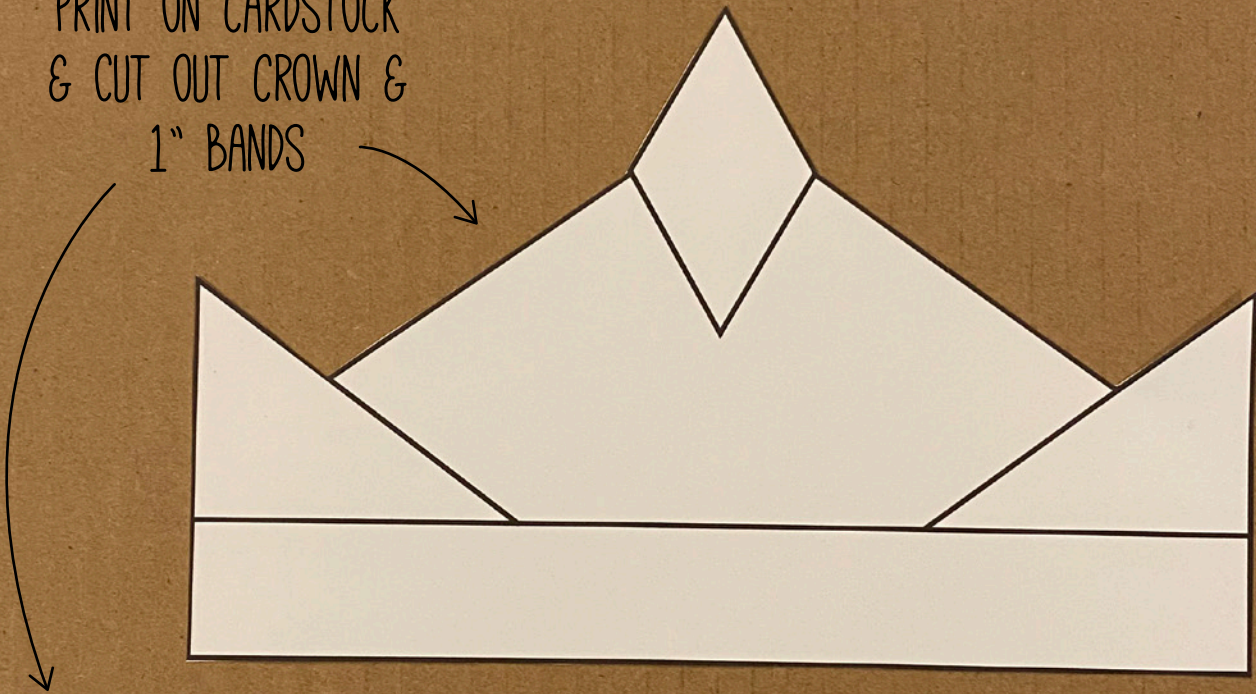

# CROWN



PLACE THE BANDS ON THE BACK OF THE CROWN  
& TAPE TOGETHER

TAPE TOGETHER THE ENDS OF THE BANDS SO IT  
FITS SNUGGLY ON THE CHILD'S HEAD

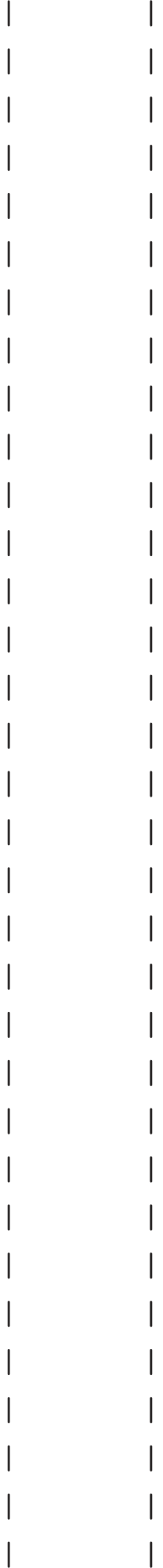
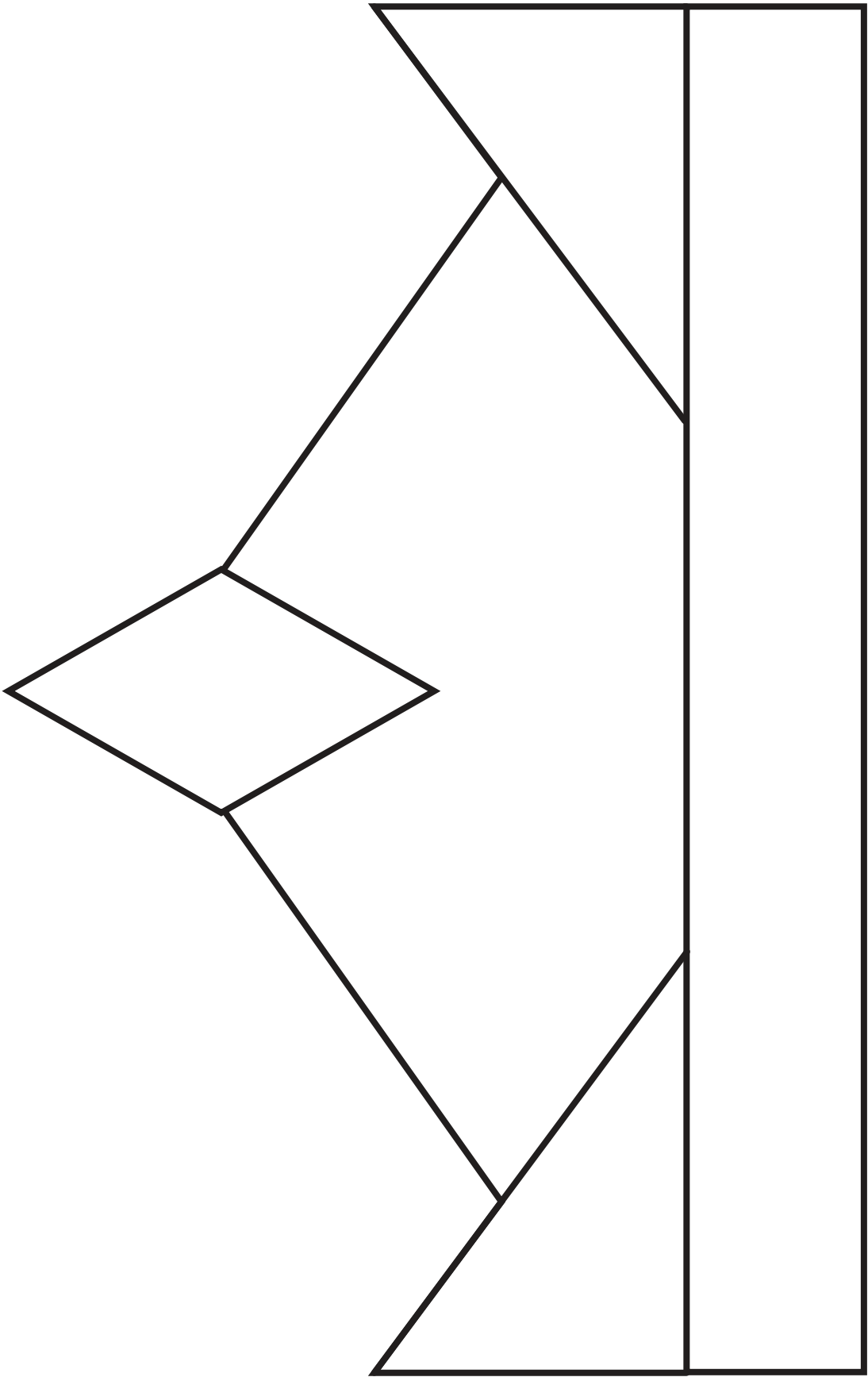

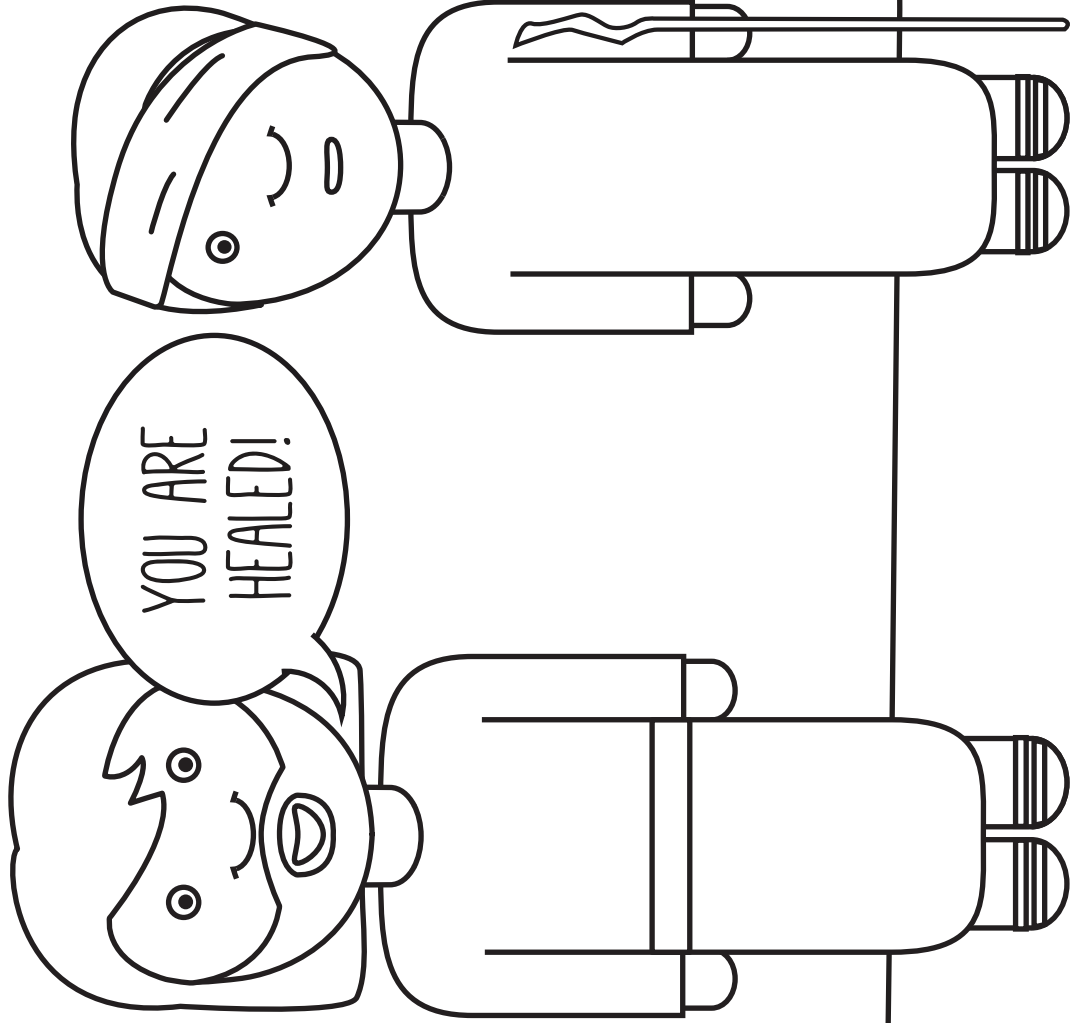

# JESUS

---

VERY TRULY I TELL YOU, WHOEVER BELIEVES IN ME WILL DO THE WORKS I HAVE BEEN DOING, AND THEY WILL DO EVEN GREATER THINGS THAN THESE, BECAUSE I AM GOING TO THE FATHER.

JOHN 14:12

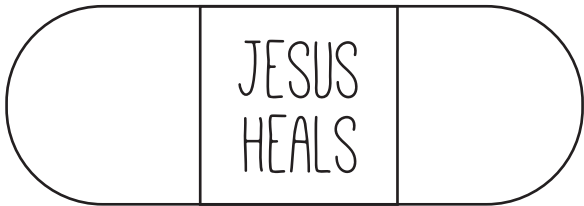
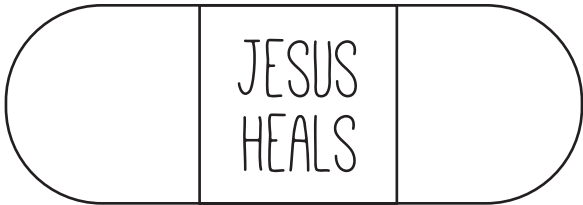
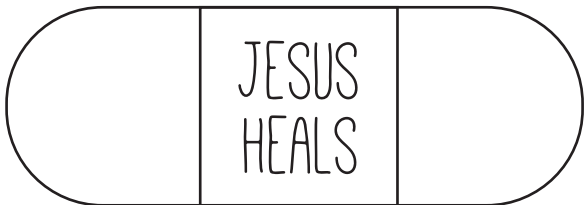
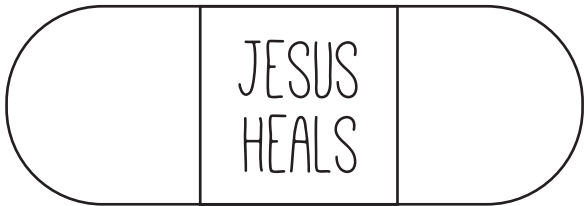
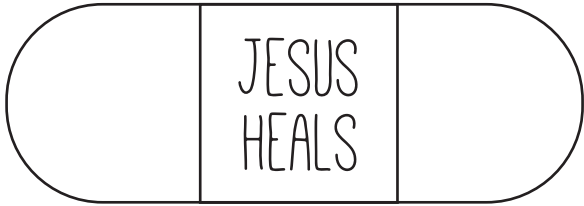
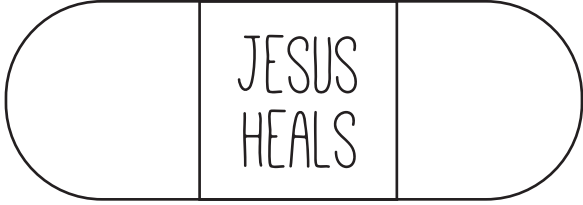
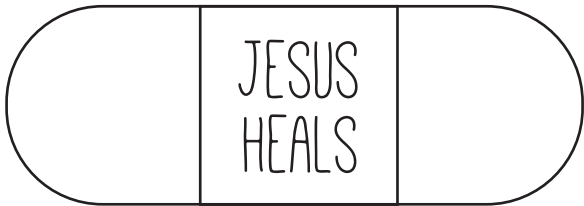

---

WRITE DOWN THE YEAR YOU WERE BORN

---

WRITE YOUR NAME

I PRAISE YOU BECAUSE I AM FEARFULLY AND WONDERFULLY MADE;  
YOUR WORKS ARE WONDERFUL, I KNOW THAT FULL WELL.

PSALM 139:14

DRAW A PICTURE OF YOURSELF!



IN THE BEGINNING GOD CREATED  
THE HEAVENS AND THE EARTH.

GENESIS 1:1

IN THE BEGINNING GOD CREATED  
THE HEAVENS AND THE EARTH.

GENESIS 1:1

IN THE BEGINNING GOD CREATED  
THE HEAVENS AND THE EARTH.

GENESIS 1:1

IN THE BEGINNING GOD CREATED  
THE HEAVENS AND THE EARTH.

GENESIS 1:1