

# SPOTLESS

## SPOTLESS

## LAMB

### FOCUS

GENESIS 22:8 & 22:13, JOHN 1:29, 1 PETER 1:19  
& REVELATION 7:17 & 22:1

Jesus is the spotless lamb!

### MATERIALS

Sheep puppet (1 per child)

Jesus puppet with accessories (1 set per child)

Jesus was the Spotless Lamb coloring page (1 per child)

Jesus on this Throne coloring page and blue streamer  
(1 set per child)

Crayons, scissors, glue and tape

### ACTIVITIES

#### 1. PROVIDE

**TALK:** Abraham and his son Isaac were on their way to go offer a burnt offering for God. Abraham told Isaac that God would provide a lamb for the offering and He did! He provided a ram!

**ACTIVITY:** Hide the sheep puppet, then have your Tiny Arrow go find, color and assemble it!

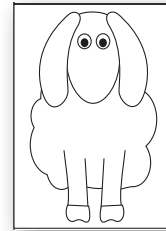

### CORRESPONDING VERSE

ABRAHAM ANSWERED, "GOD HIMSELF WILL PROVIDE THE LAMB FOR THE BURNT OFFERING, MY SON." AND THE TWO OF THEM WENT ON TOGETHER.

GENESIS 22:8

HE WENT OVER AND TOOK THE RAM AND SACRIFICED IT AS A BURNT OFFERING INSTEAD OF HIS SON.

GENESIS 22:13

#### 2. LAMB OF GOD

**TALK:** God sent his son Jesus to the earth and Jesus is the Lamb of God!

**ACTIVITY:** Help your Tiny Arrow color, and assemble the Jesus puppet.

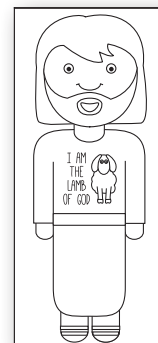

THE NEXT DAY JOHN SAW JESUS COMING TOWARD HIM AND SAID, "LOOK, THE LAMB OF GOD, WHO TAKES AWAY THE SIN OF THE WORLD!"

JOHN 1:29

## ACTIVITIES

### 3. SPOTLESS

**TALK:** Jesus was a special type of lamb! He did not have any blemish or spot! That means he had never sinned!

**ACTIVITY:** Have your Tiny Arrow color the Jesus was the Spotless Lamb coloring page and find the spotless lamb!

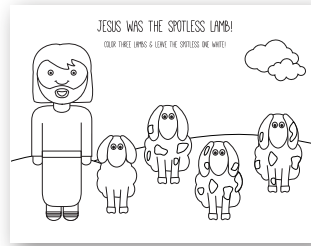

## CORRESPONDING VERSE

BUT WITH THE PRECIOUS BLOOD OF CHRIST, A LAMB WITHOUT BLEMISH OR DEFECT.

1 PETER 1:19

### 4. SHEPHERD & KING

**TALK:** Jesus, the Lamb of God is our shepherd and king! He even has a staff and throne!

**ACTIVITY:** Have your Tiny Arrow glue the crown and staff on the Jesus puppet!

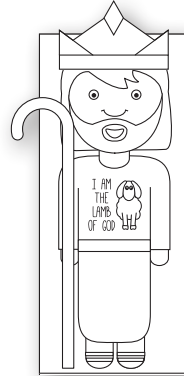

FOR THE LAMB AT THE CENTER OF THE THRONE WILL BE THEIR SHEPHERD

REVELATION 7:17

### 5. THRONE

**TALK:** Jesus' throne has living water flowing from it!

**ACTIVITY:** Have your Tiny Arrow color and fold Jesus's throne, then tape a blue streamer to the bottom of the throne so it flows down like water!

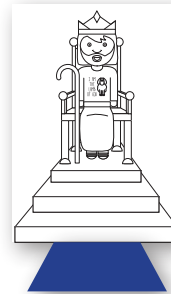

THEN THE ANGEL SHOWED ME THE RIVER OF THE WATER OF LIFE, AS CLEAR AS CRYSTAL, FLOWING FROM THE THRONE OF GOD AND OF THE LAMB

REVELATION 22:1

### 6. LIVING WATER

**TALK:** Jesus' leads us to Living Water to drink from!

**ACTIVITY:** Have your Tiny Arrow bring the sheep puppet to the water and have the sheep puppet take a drink from it!

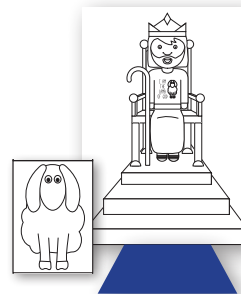

'HE WILL LEAD THEM TO SPRINGS OF LIVING WATER.'

REVELATION 7:17

**OPTIONAL:** Hand out each child a bible verse to take home.

FOR THE LAMB AT THE CENTER OF THE THRONE WILL BE THEIR SHEPHERD

REVELATION 7:17

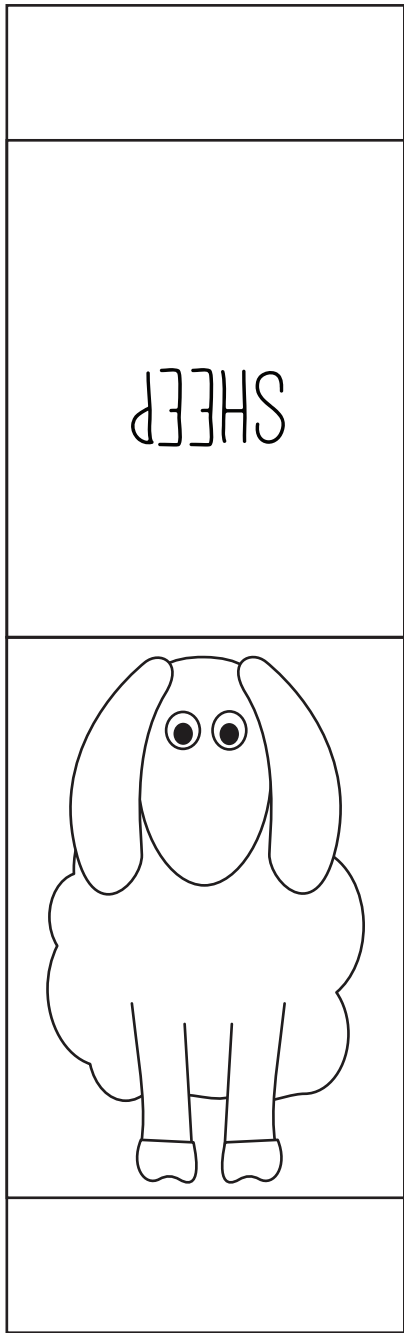
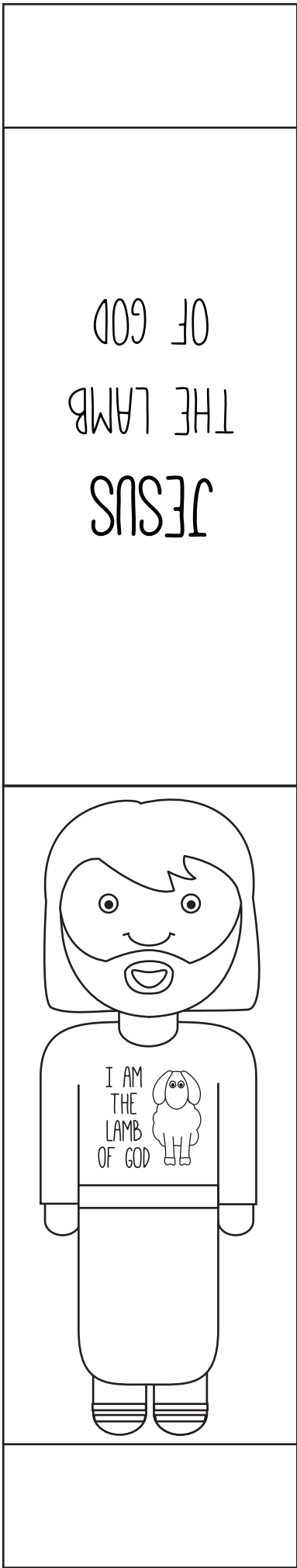

CUT OUT, FOLD  
& GLUE ENDS  
TOGETHER

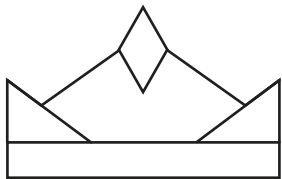
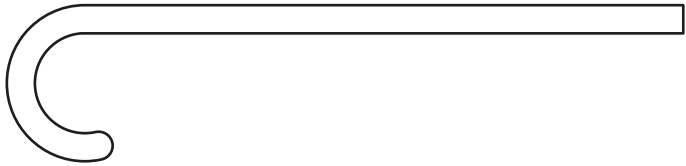
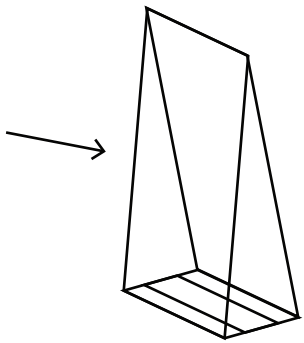

# JESUS WAS THE SPOTLESS LAMB!

COLOR THREE LAMBS & LEAVE THE SPOTLESS ONE WHITE!

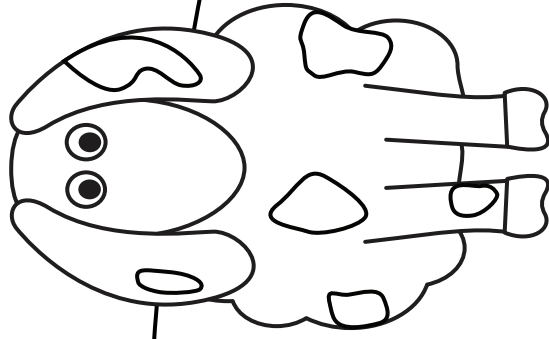
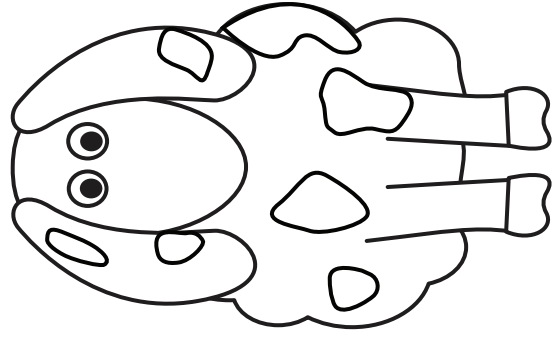
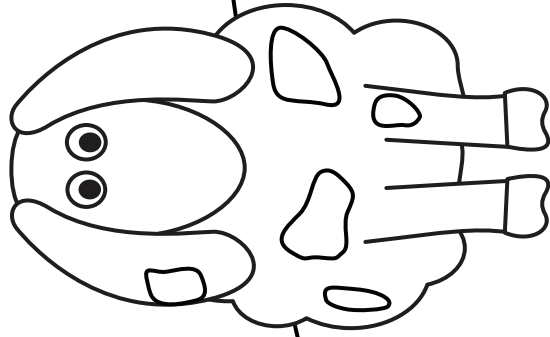
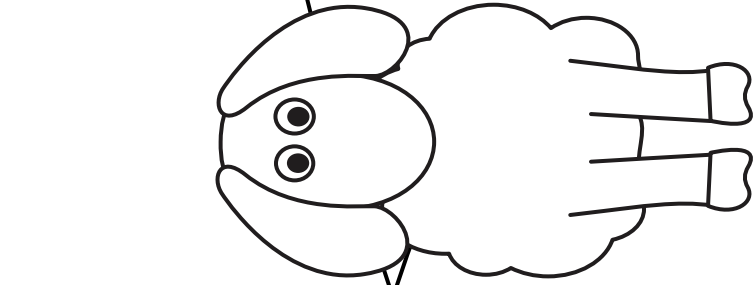
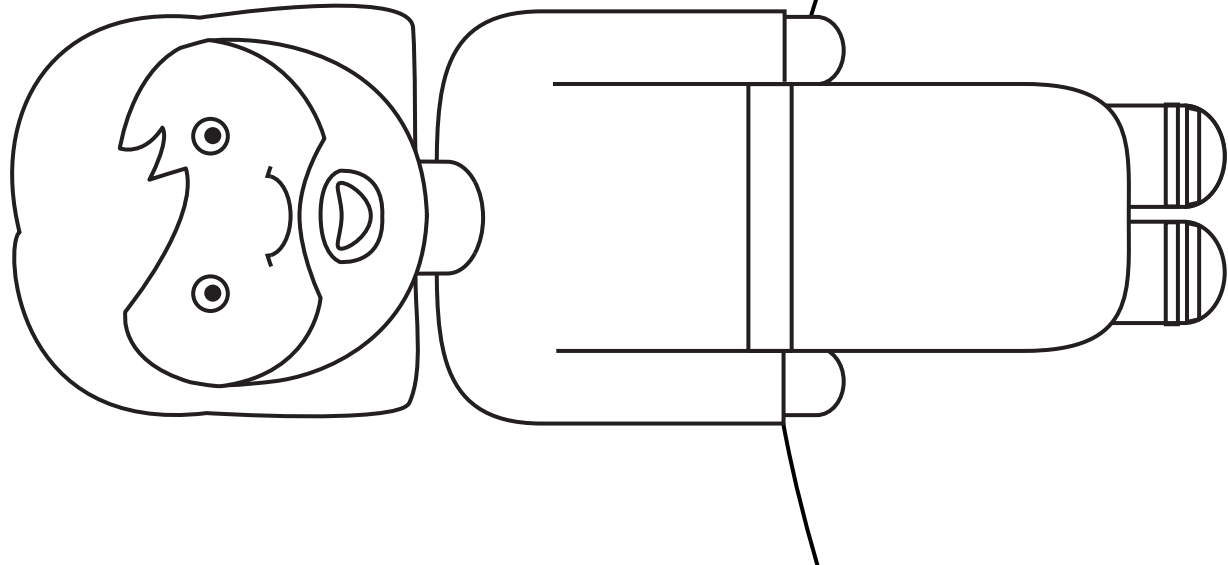
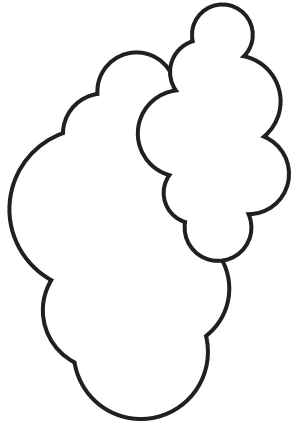

# JESUS ON THRONE

PRINT

12IN BLUE STREAMER

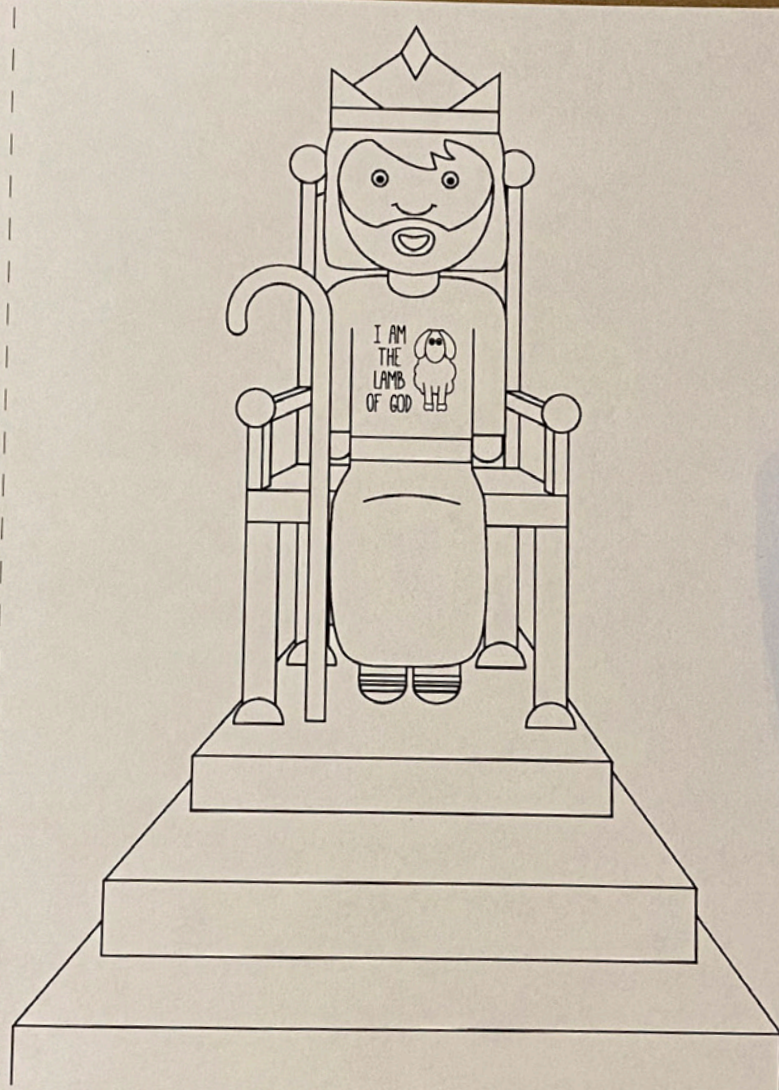

FOLD IN

# JESUS ON THRONE

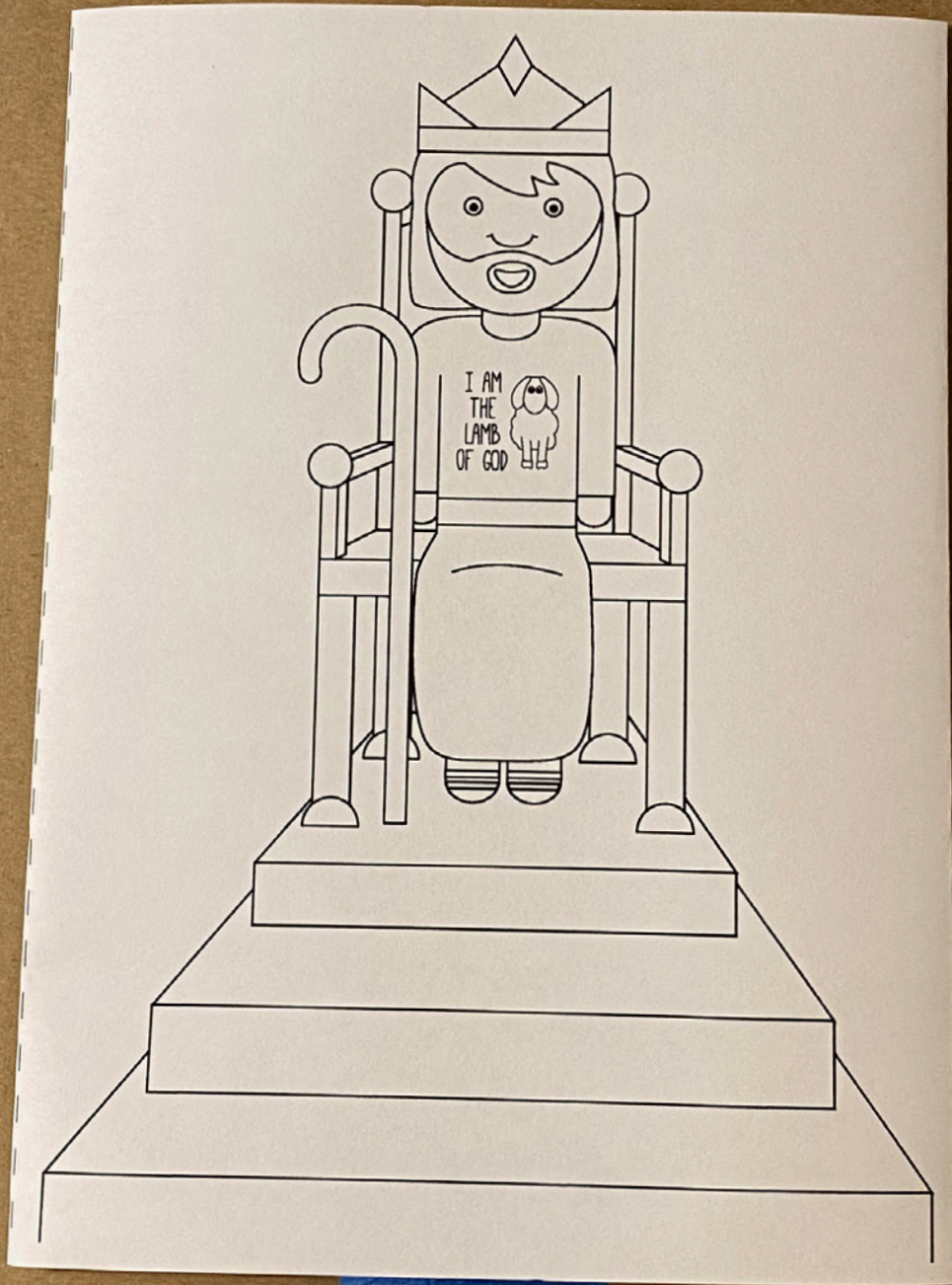

TAPE THE STREAMER  
TO THE BACK OF  
THE PAGE

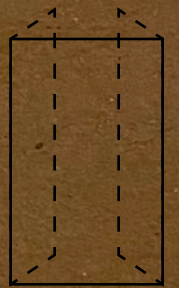

STAND THE PAGE  
UP, WITH THE  
FOLDED ENDS  
SUPPORTING  
THE PAPER

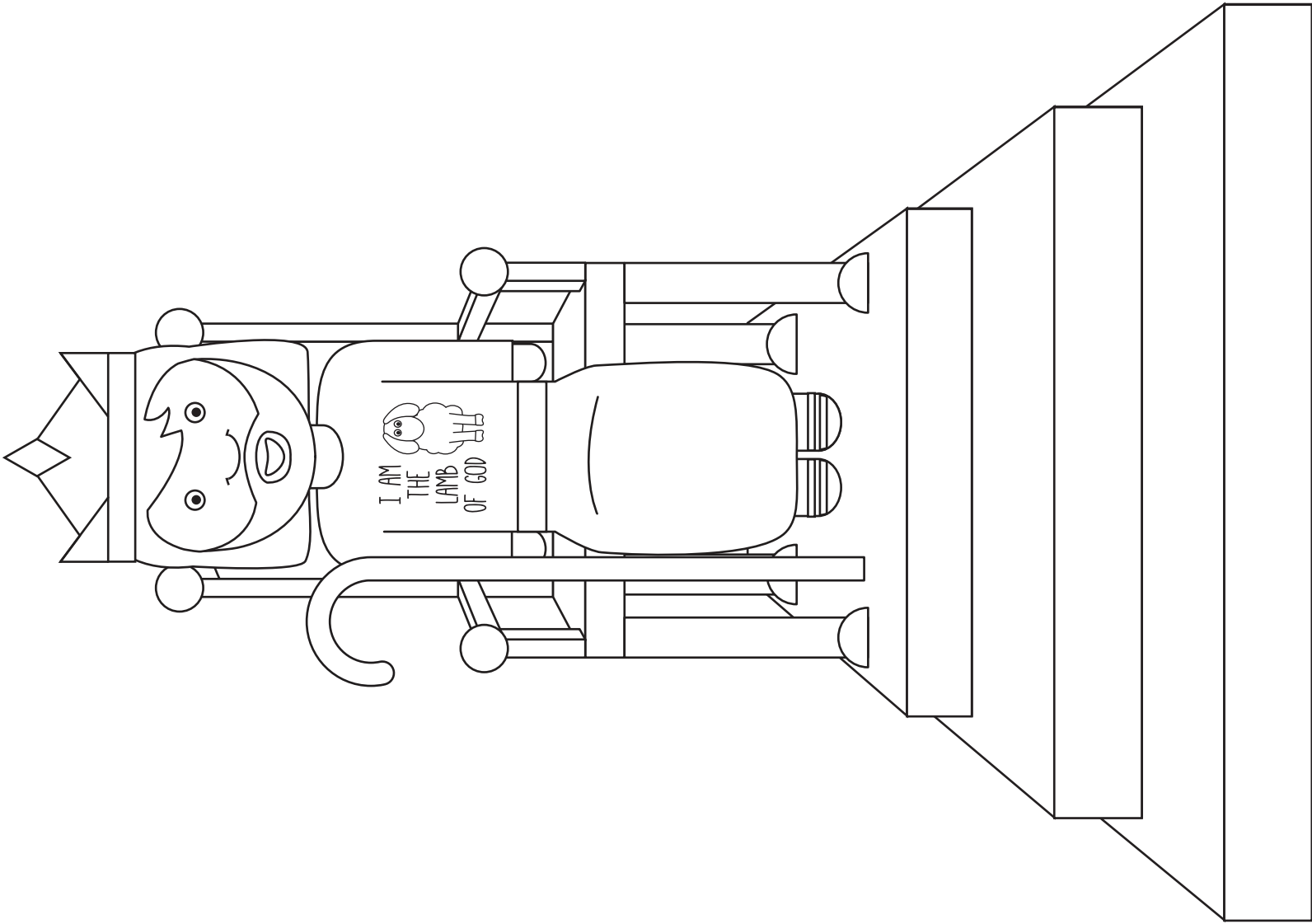

FOR THE LAMB AT THE  
CENTER OF THE THRONE  
WILL BE THEIR SHEPHERD

REVELATION 7:17

FOR THE LAMB AT THE  
CENTER OF THE THRONE  
WILL BE THEIR SHEPHERD

REVELATION 7:17

FOR THE LAMB AT THE  
CENTER OF THE THRONE  
WILL BE THEIR SHEPHERD

REVELATION 7:17

FOR THE LAMB AT THE  
CENTER OF THE THRONE  
WILL BE THEIR SHEPHERD

REVELATION 7:17